

PawHut

INdcb055V03_GL

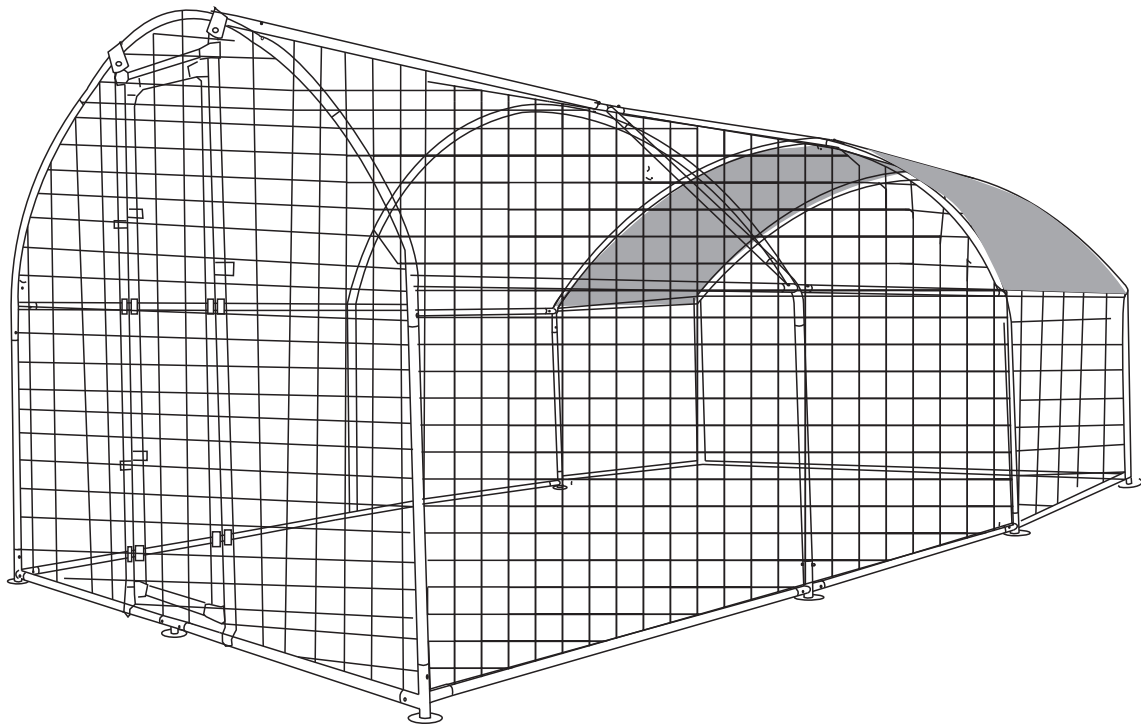









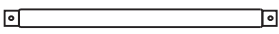
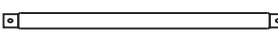
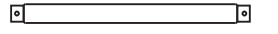
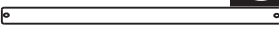
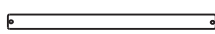

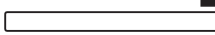
D51-117

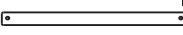

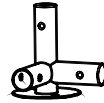
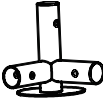
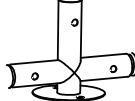
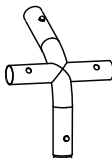

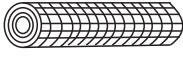
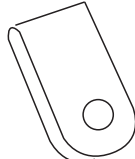
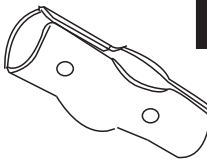

IMPORTANT, RETAIN FOR FUTURE REFERENCE: READ CAREFULLY

ASSEMBLY & INSTRUCTION MANUAL

PARTS

 <p>1 x 4 1320MM</p>	 <p>2 x 12 1825MM</p>	 <p>3 x 8 970MM</p>
 <p>5 x 2 1830MM</p>	 <p>6 x 1 635MM</p>	 <p>7 x 8 1120MM</p>
 <p>8 x 4 1120MM</p>	 <p>9 x 3 1860MM</p>	 <p>A x 2 1700MM</p>
 <p>C x 2 497MM</p>	 <p>D x 4</p>	 <p>E1 x 2</p>
 <p>E2 x 2</p>	 <p>F x 4</p>	 <p>H x 4</p>
 <p>G x 2</p>	 <p>I x 20</p>	 <p>J x 2</p>
 <p>M x 1</p>	 <p>O x 1</p>	 <p>P x 1</p>
 <p>Q x 1</p>	 <p>T x 2</p>	 <p>U x 2</p>

HARDWARE

 <p>K x 16 M8</p>	 <p>L x 4 M10</p>	 <p>R x 16</p>	 <p>S x 1</p>
---	---	---	---

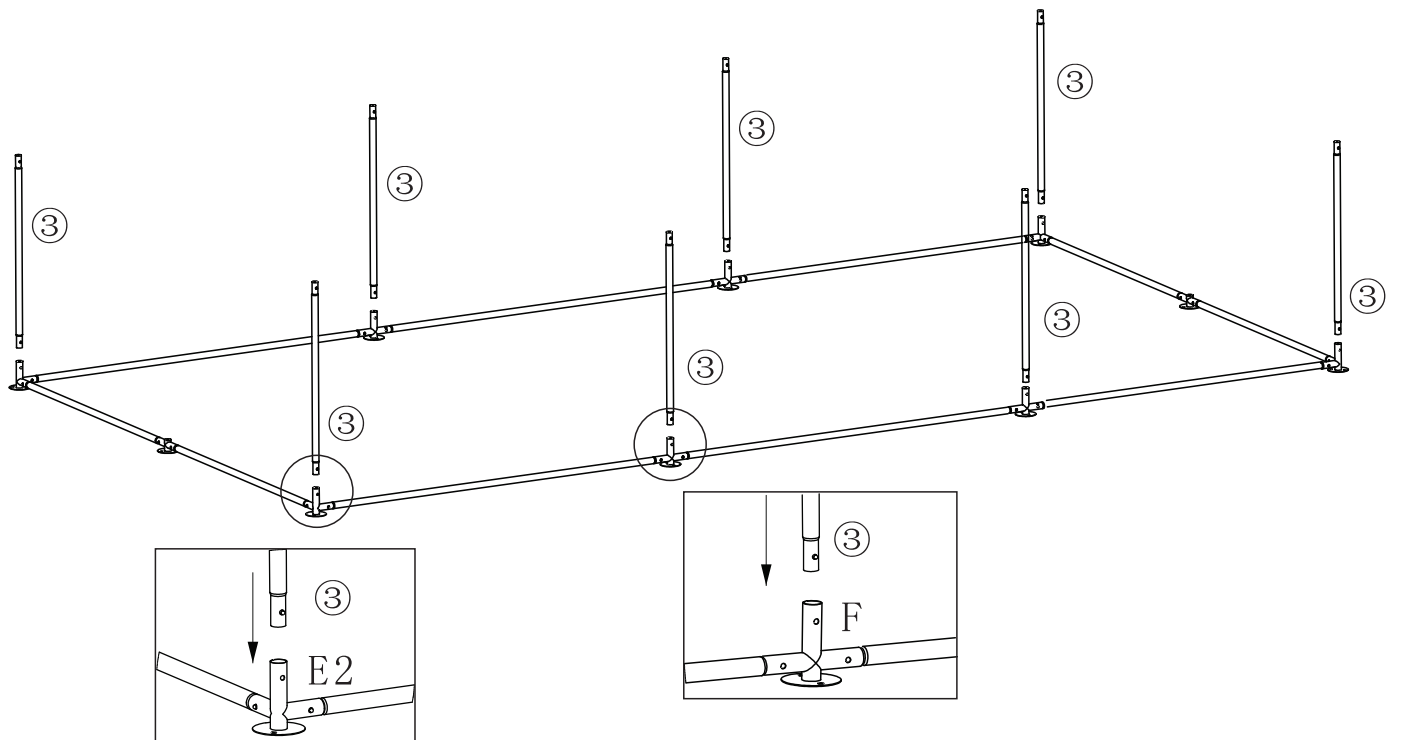
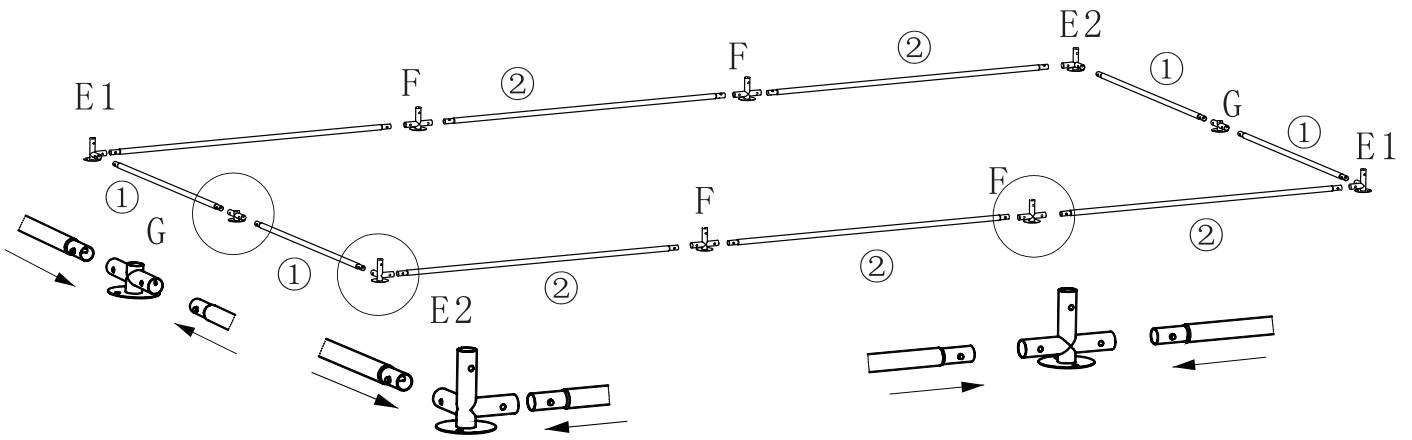

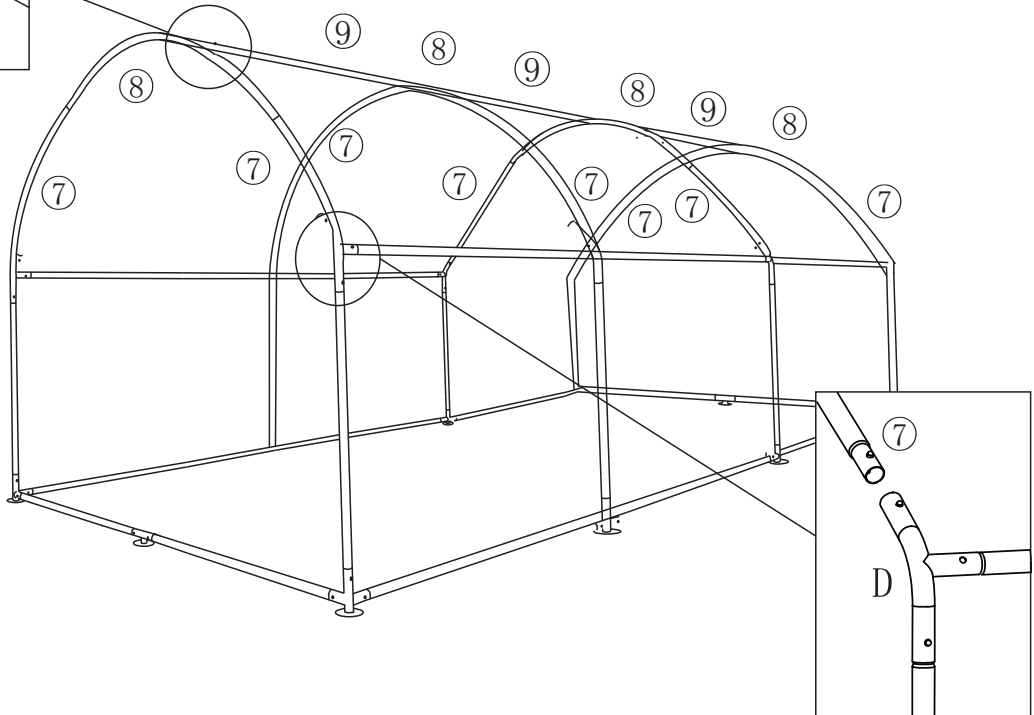
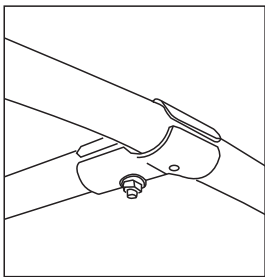
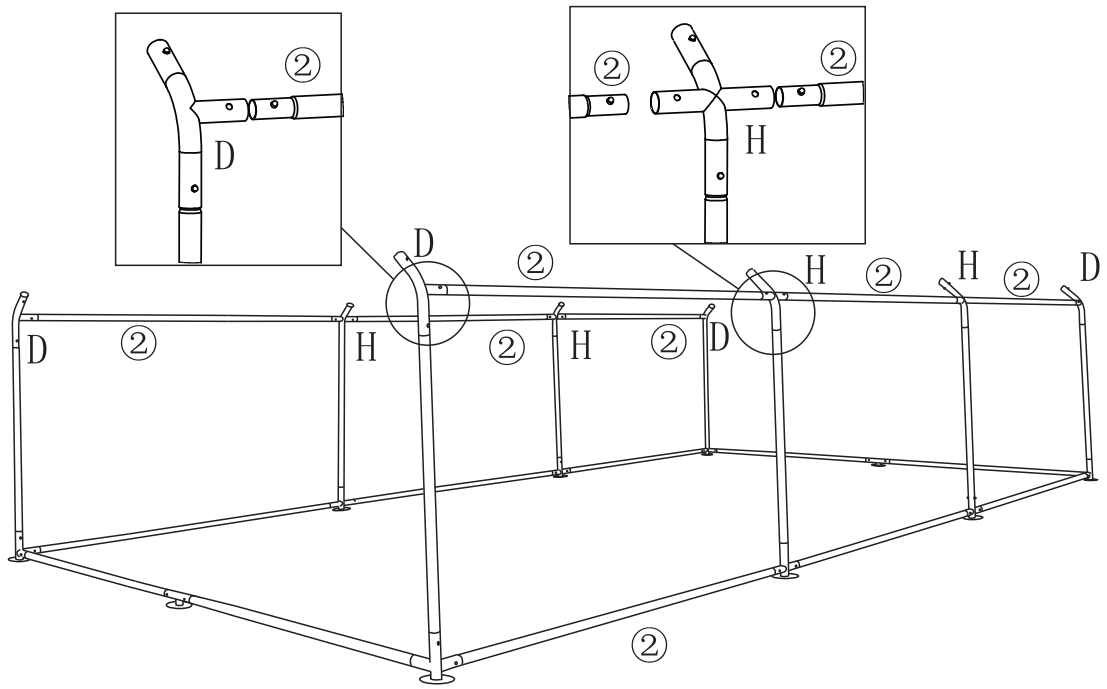

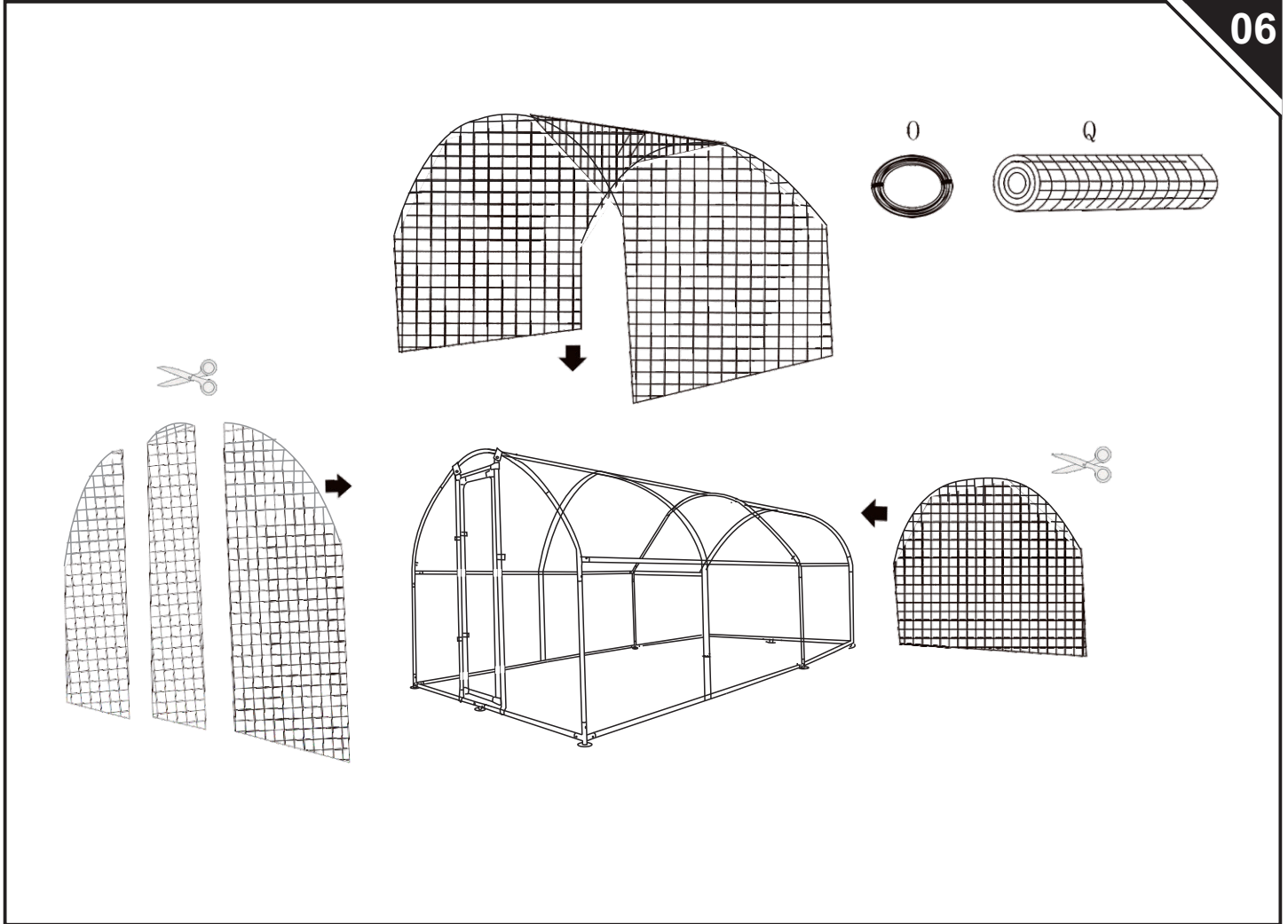
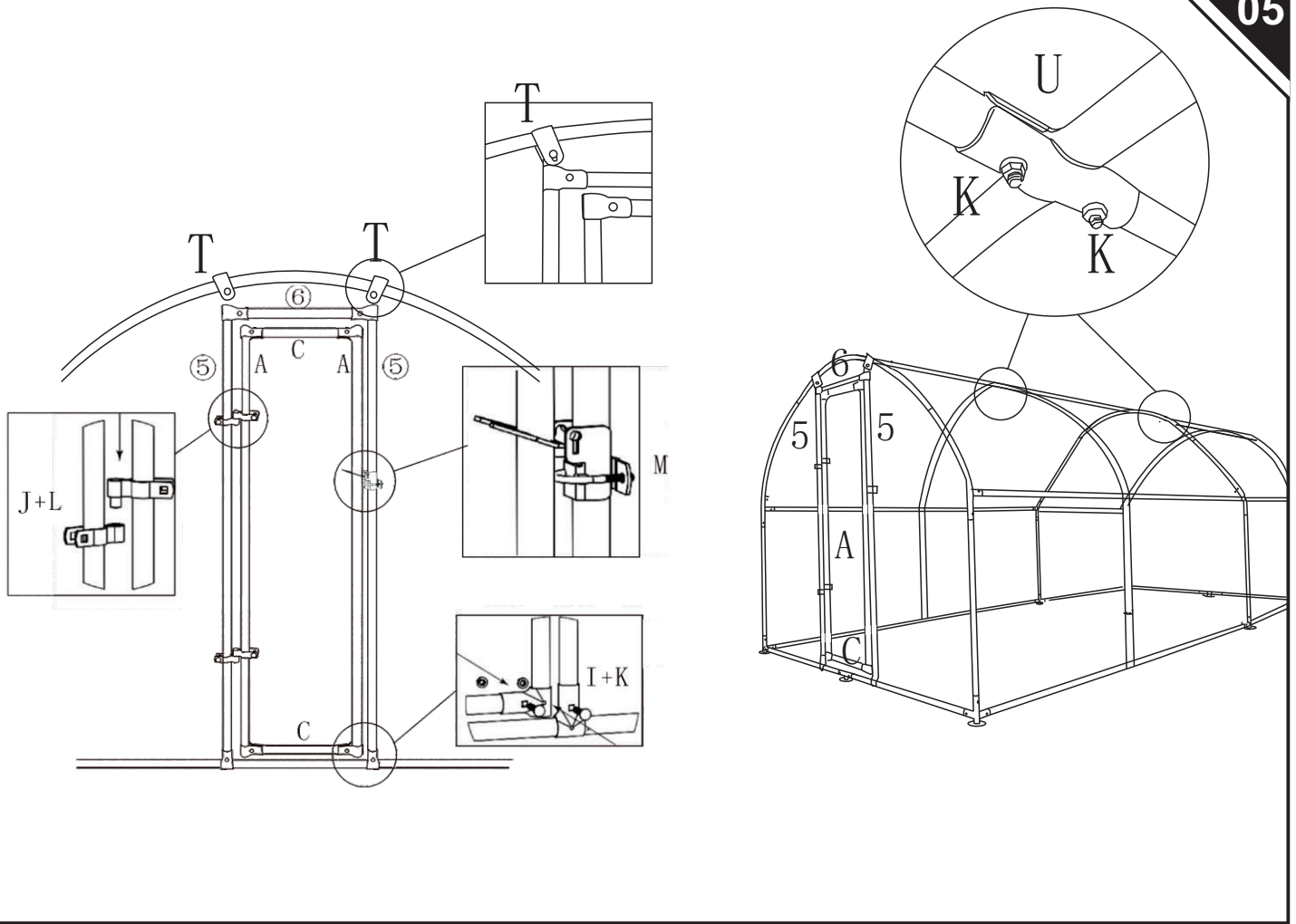

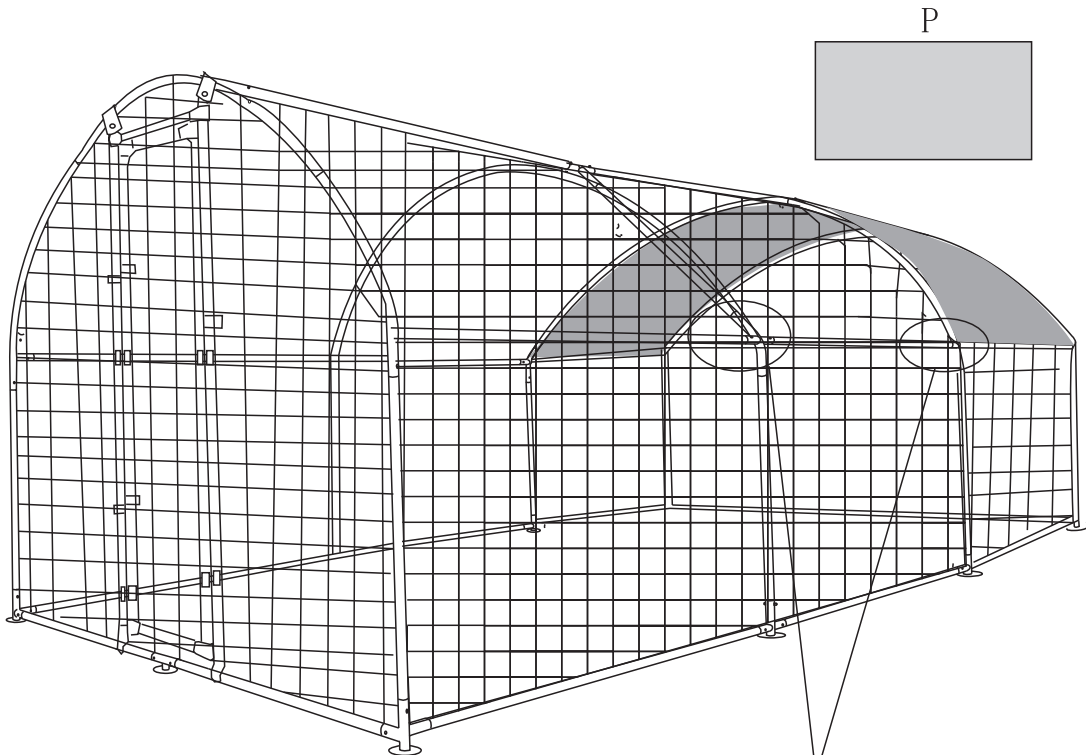
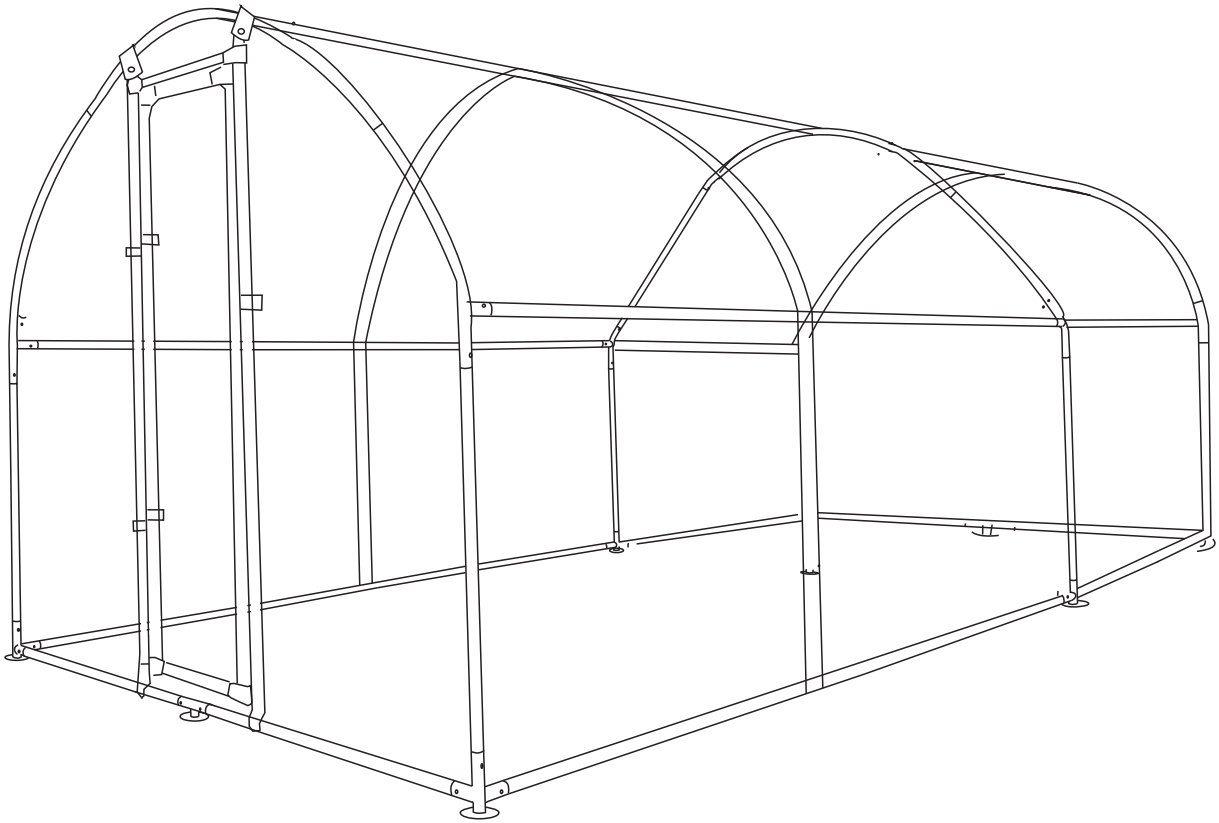

P



R

