

PawHut

INdcc021V01_US_CA

D32-003

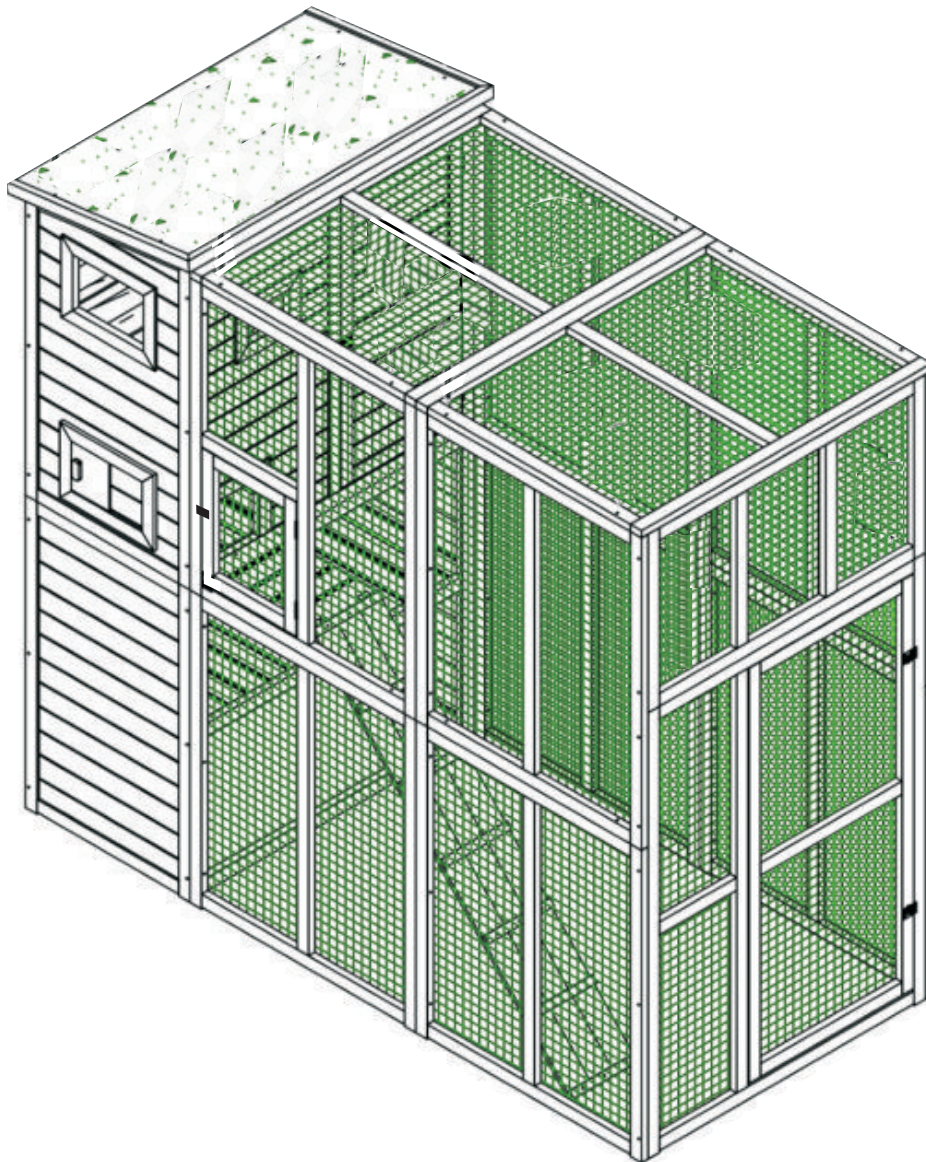

EN_IMPORTANT, RETAIN FOR FUTURE REFERENCE: READ CAREFULLY.



FR_IMPORTANT: A LIRE ATTENTIVEMENT ET À CONSERVER POUR CONSULTATION ULTÉRIEURE.

ES_IMPORTANTE, LEA Y GUARDE PARA FUTURAS REFERENCIAS.

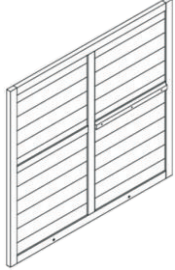

DE_WICHTIG! SORGFÄLTIG LESEN UND FÜR SPÄTER NACHSCHLAGEN AUFBEWAHREN.

IT_IMPORTANTE! CONSERVARE IL PRESENTE MANUALE PER FUTURO RIFERIMENTO E LEGGERLO ATTENTAMENTE.

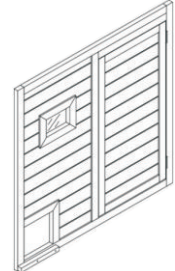
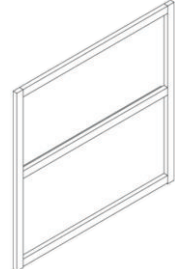
BOX-1/3

NO.	PARTS	QTY
4		1
5		1
6		1
7		1

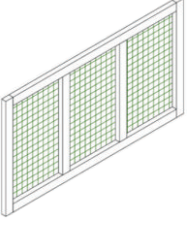
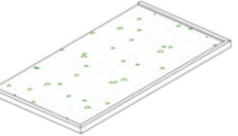
BOX-1/3

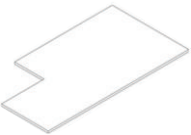
NO.	PARTS	QTY
16		1
19		1
21		1
24		1

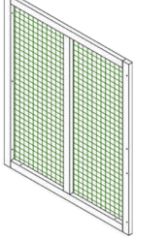
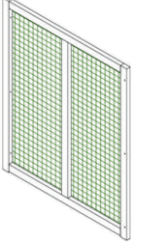
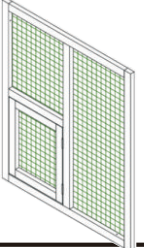
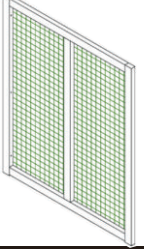
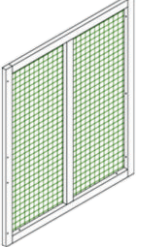

BOX-2/3

NO.	PARTS	QTY
8		1
9		1
10		1
11		1
12		1

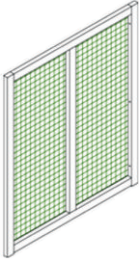
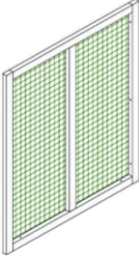
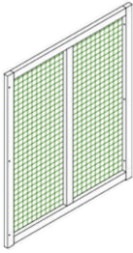
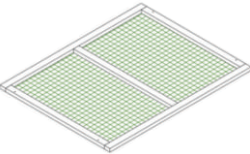

BOX-2/3

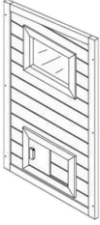
NO.	PARTS	QTY
13		1
14		1
15		1
18		2

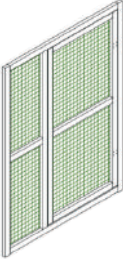
BOX-3/3

NO.	PARTS	QTY
1		1
2		1
3		2
17		1

BOX-3/3

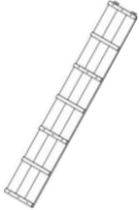
NO.	PARTS	QTY
20		2
22		4
23		1
25		1

① x 1

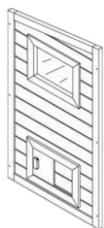

② x 1



③ x 2

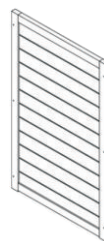

④ x 1



⑤ x 1



⑥ x 1

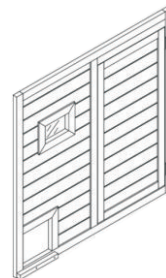

⑦ x 1

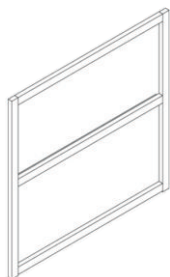

⑧ x 1

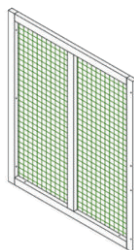

⑨ x 1

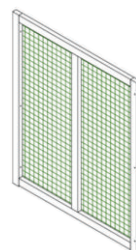

⑩ x 1

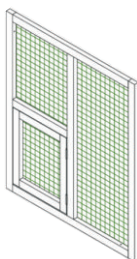

⑪ x 1

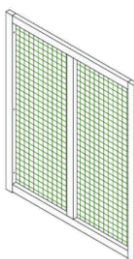

⑫ x 1

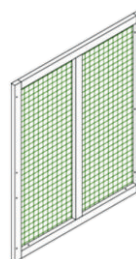

⑬ x 1

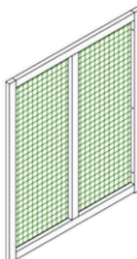

⑭ x 1

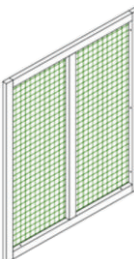

⑮ x 1

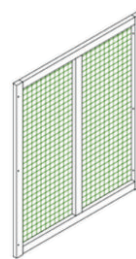

PARTS

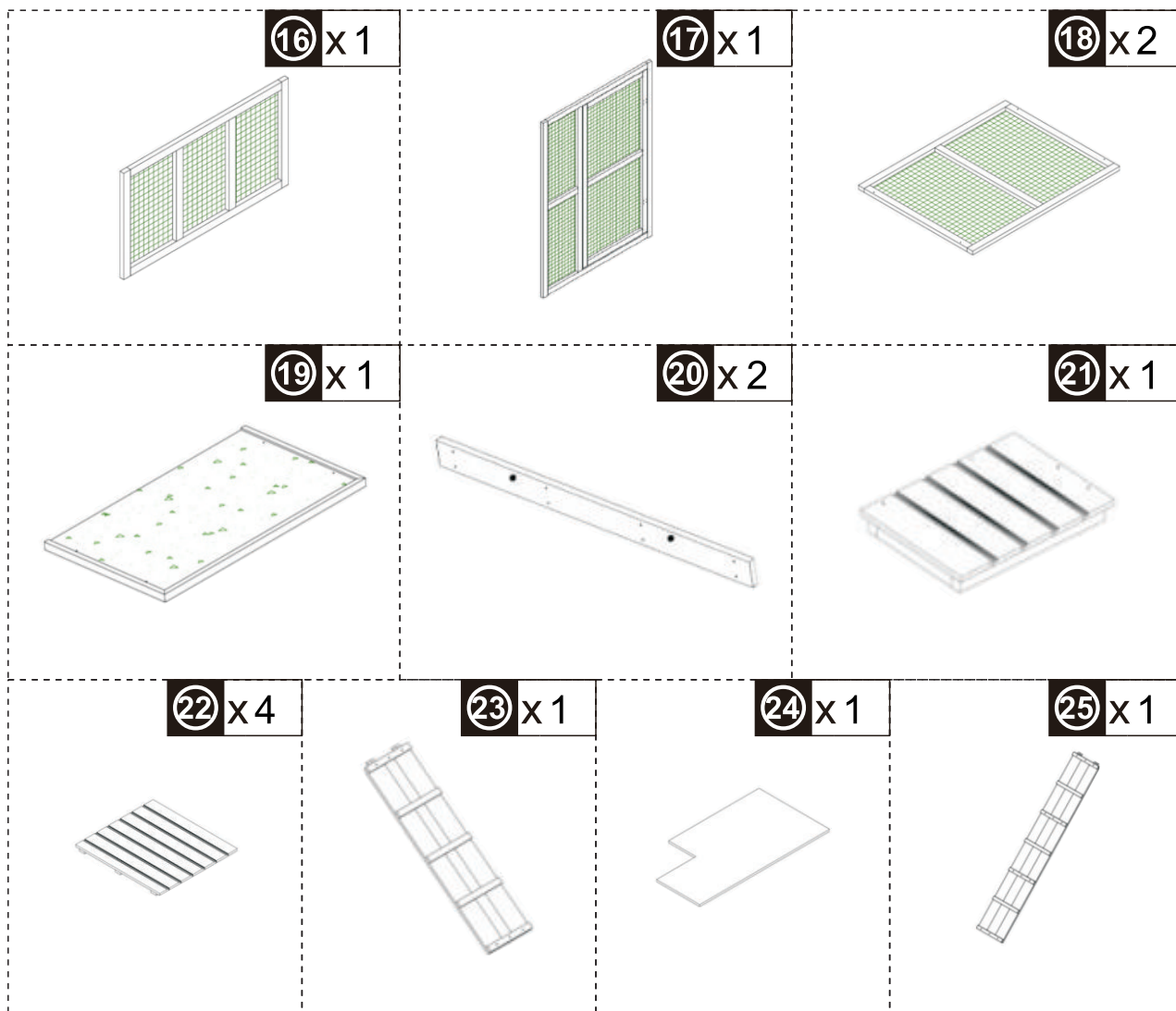

HARDWARE

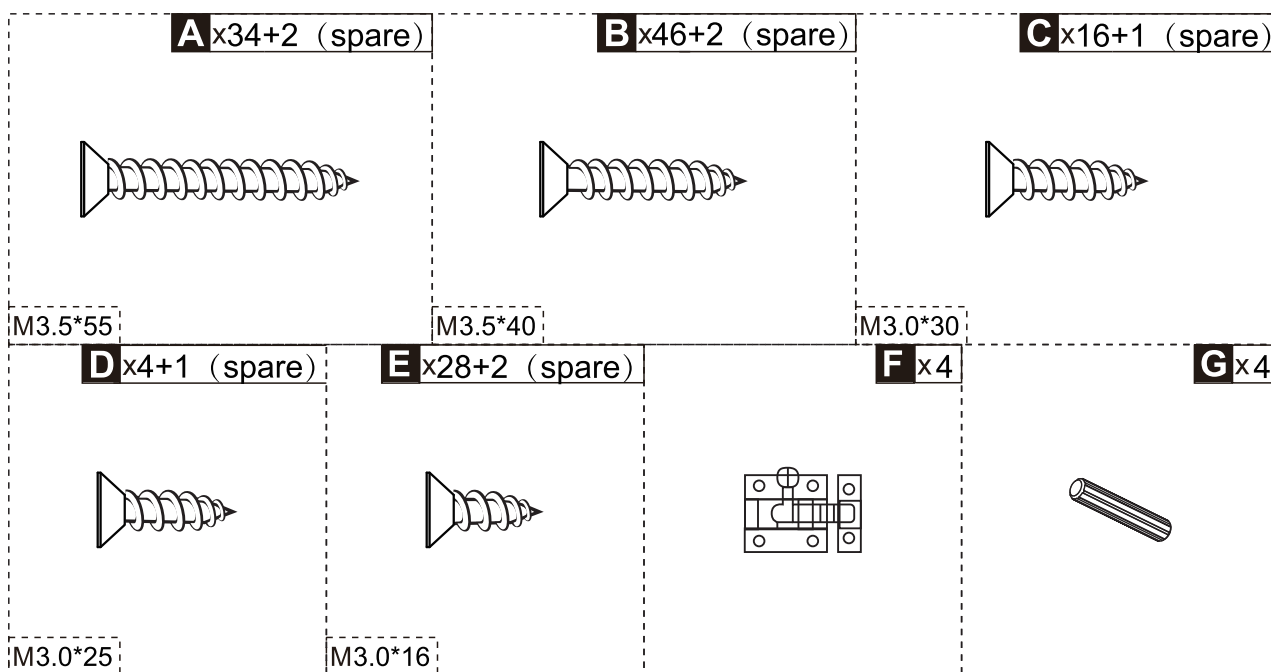

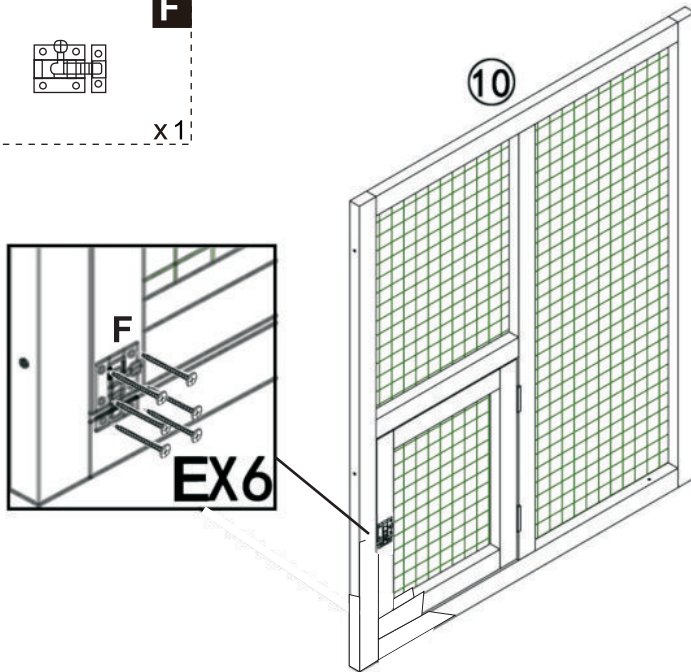
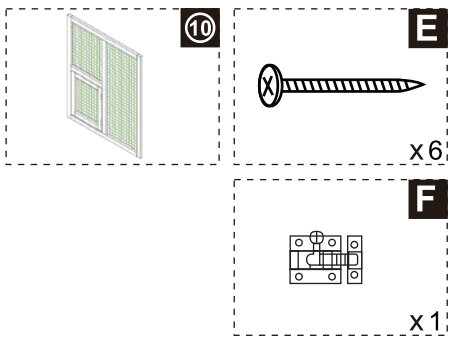
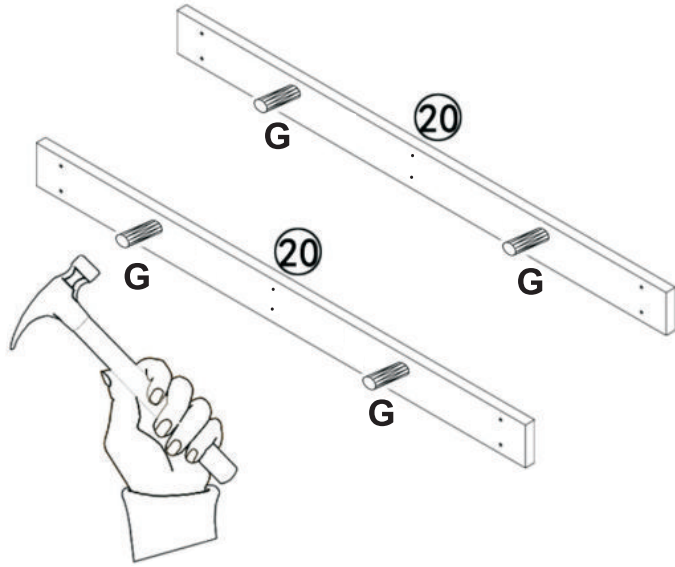
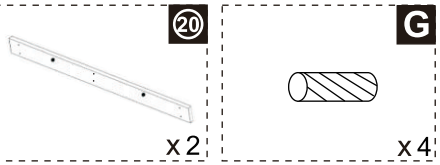



6



E

x 6



F

x 1

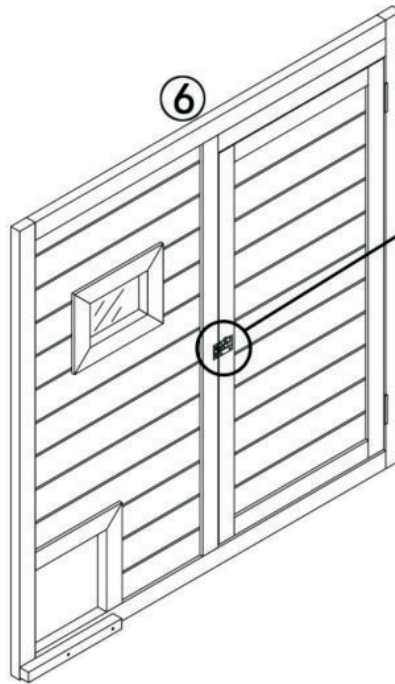

6

F

EX6



6



C

x 6

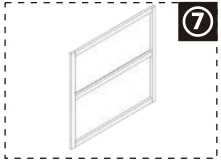

7

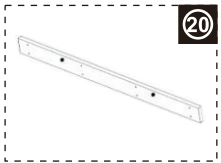

20

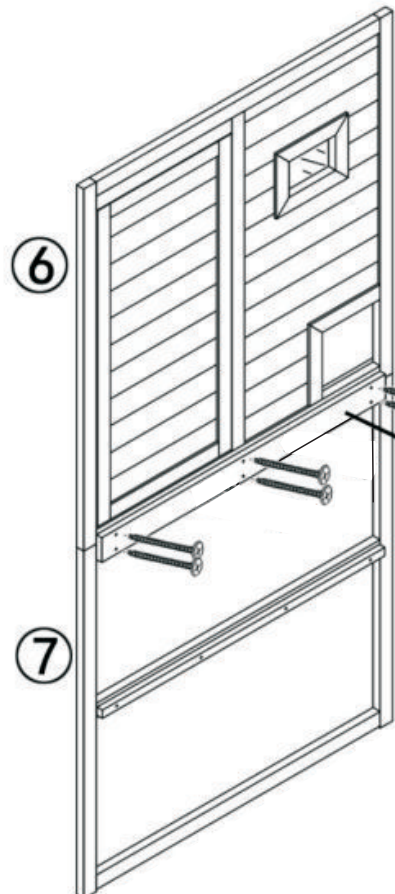

6

CX6

20

7

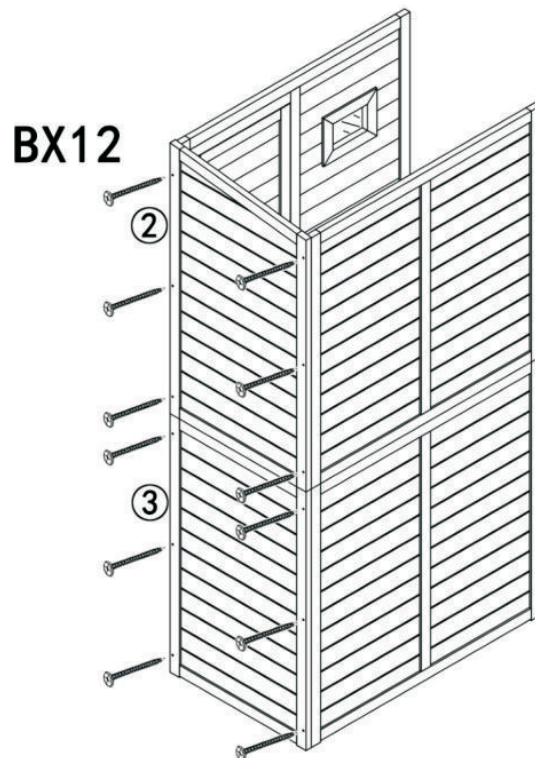
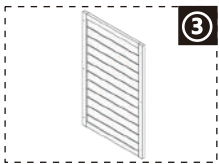
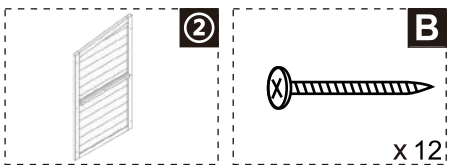
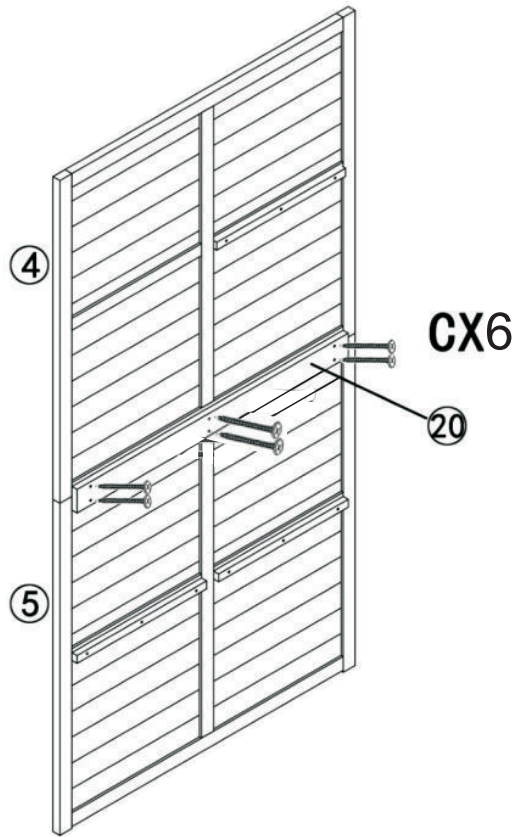
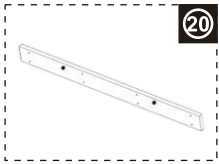
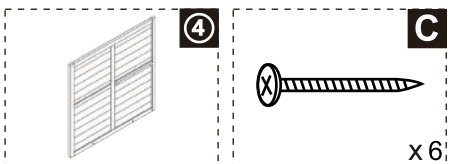

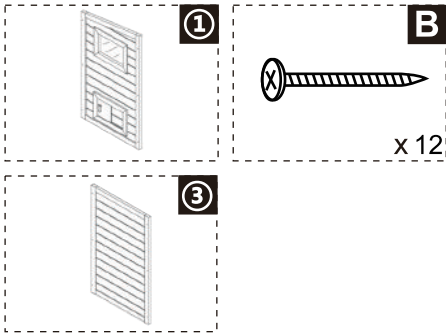

BX12

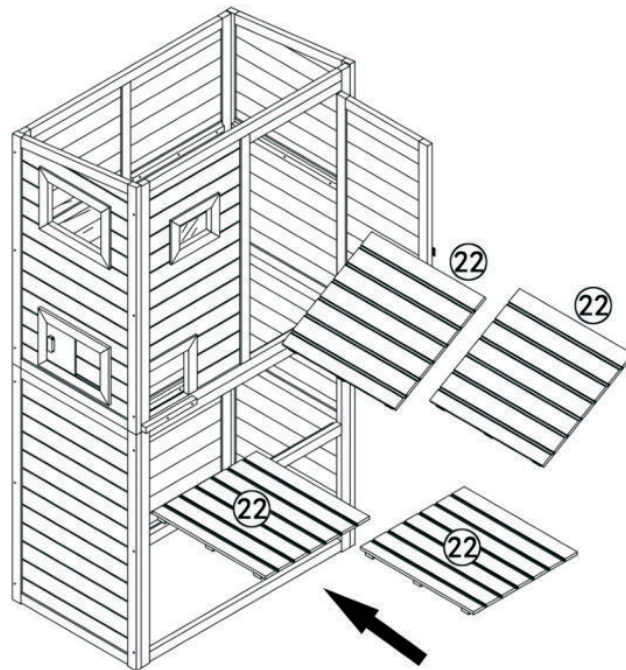
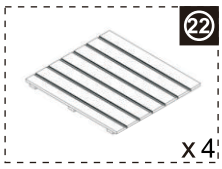
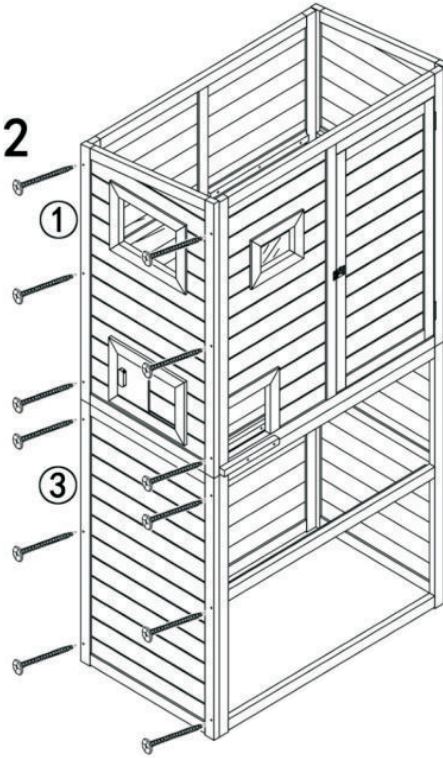

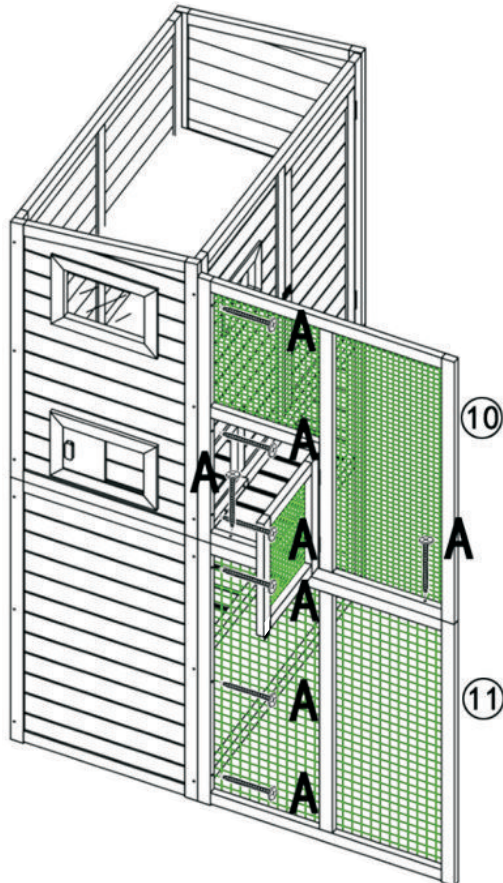
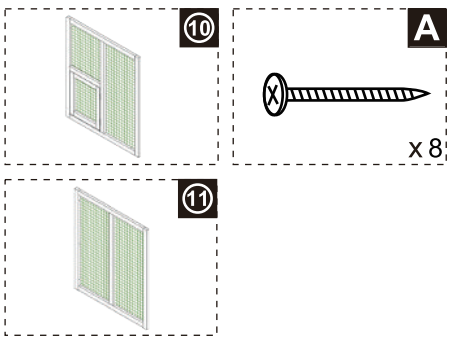
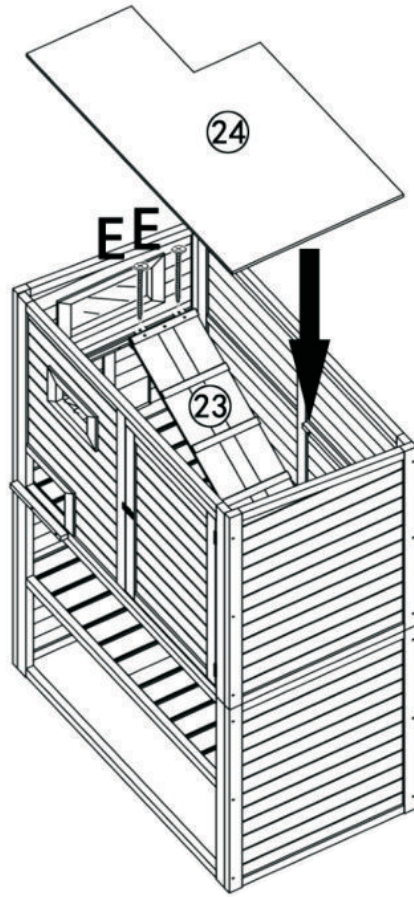
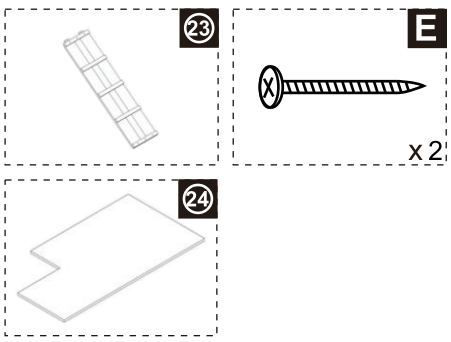

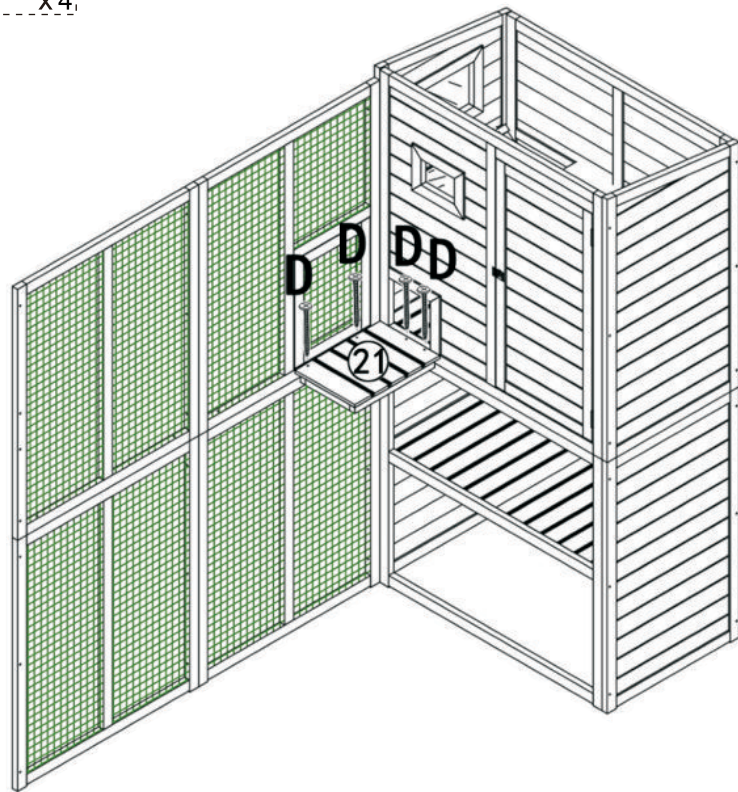
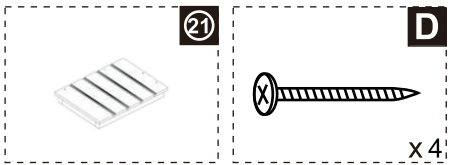
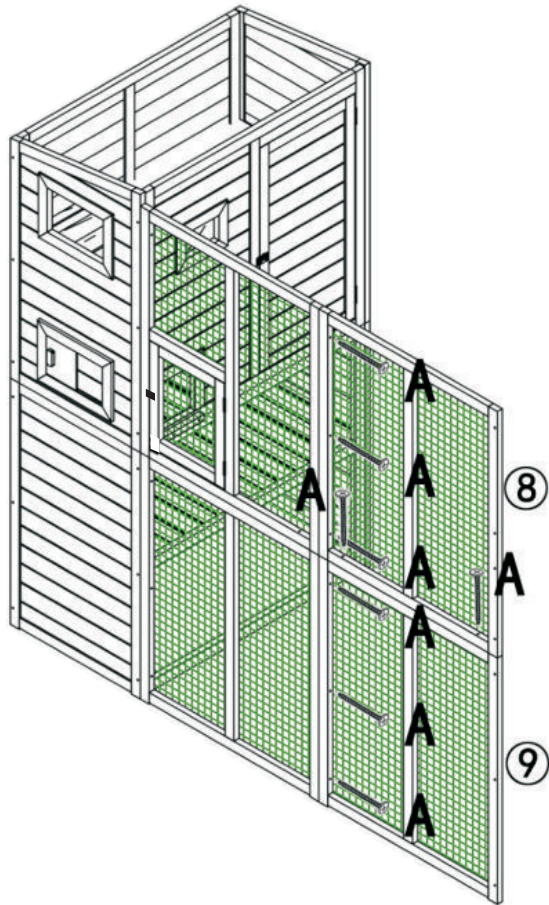
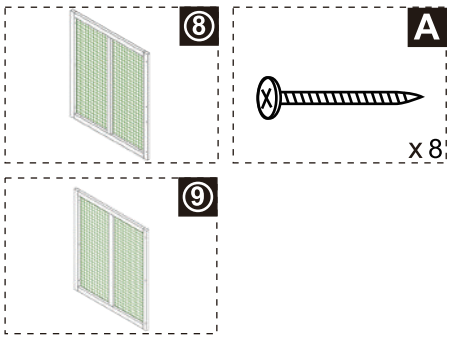

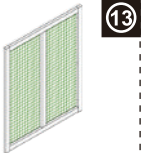

13

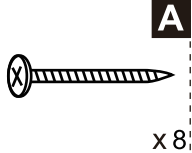

A

x 8

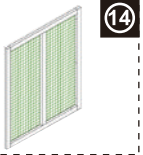

14

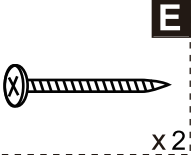

E

x 2

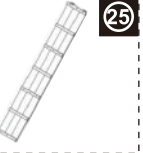

25

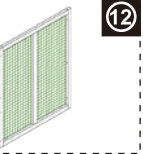
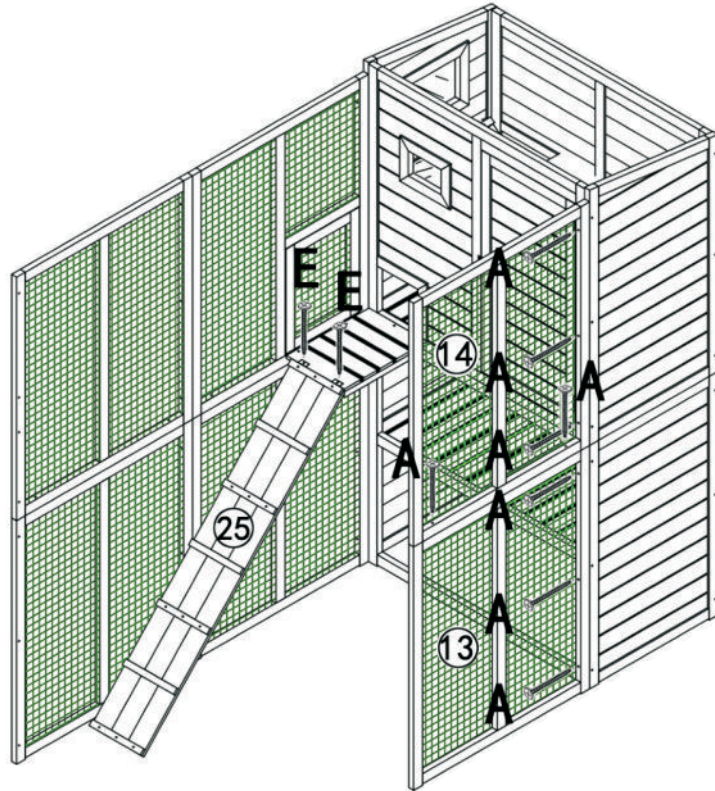

12

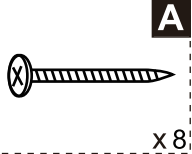

A

x 8

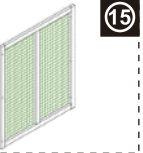

15

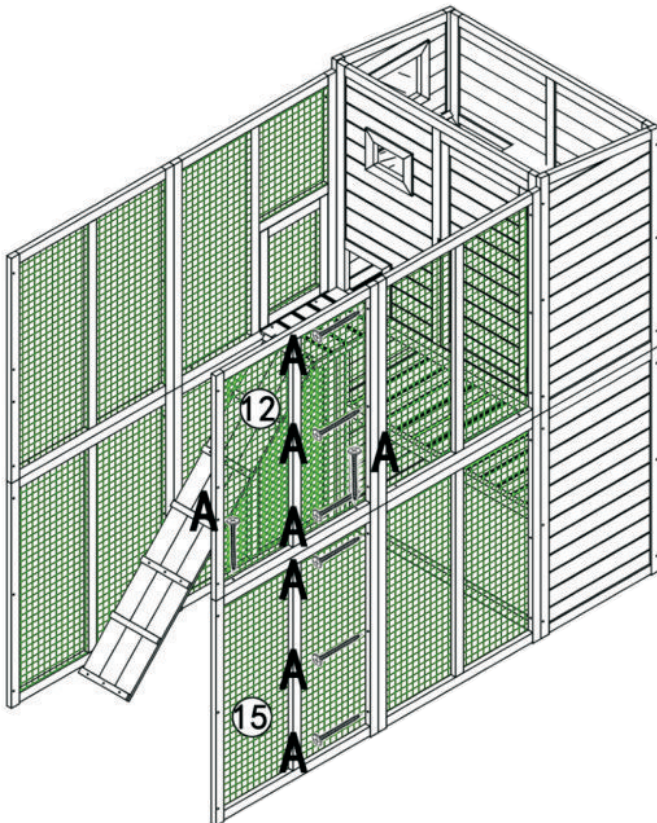

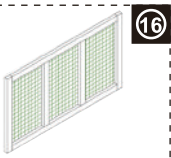

16



B

x 14

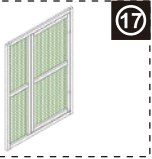

17



E

x 12

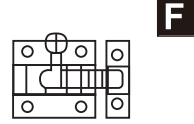

F

x 2

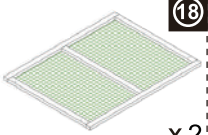
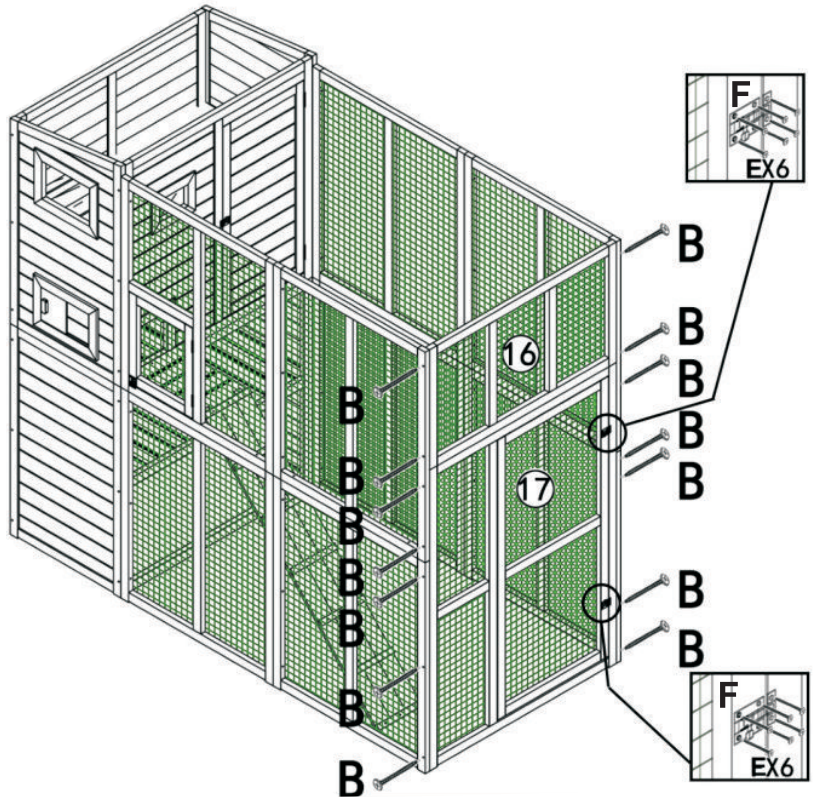

18

x 2



A

x 2

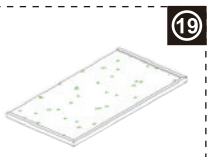

19



B

x 8



C

x 4

