

PawHut®

INdha014V02_GL

D30-035

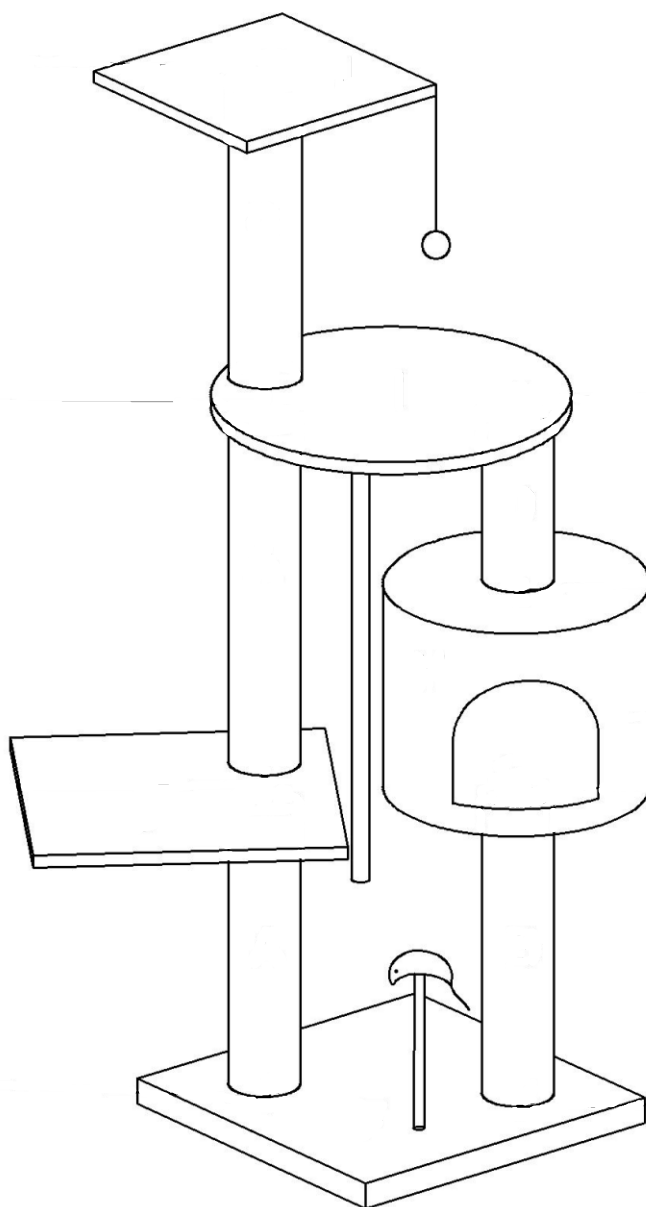

EN_IMPORTANT, RETAIN FOR FUTURE REFERENCE: READ CAREFULLY.

FR_IMPORTANT: A LIRE ATTENTIVEMENT ET À CONSERVER POUR CONSULTATION ULTÉRIEURE.

ES_IMPORTANTE, LEA Y GUARDE PARA FUTURAS REFERENCIAS.

DE_WICHTIG! SORGFÄLTIG LESEN UND FÜR SPÄTER NACHSCHLAGEN AUFBEWAHREN.

IT_IMPORTANTE! CONSERVARE IL PRESENTE MANUALE PER FUTURO RIFERIMENTO E LEGGERLO ATTENTAMENTE.

A x 2

D7*40cm

B x 1

D7*37cm

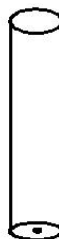
C x 1

D7*25cm

D x 1

D7*20cm

E x 2

D5*22.5cm

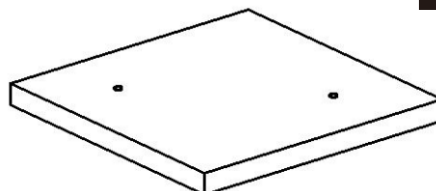
F x 1

40*40cm

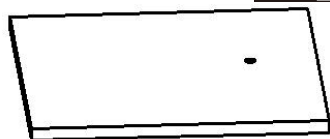
G x 1

35*30cm

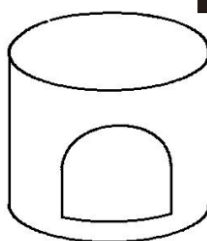
H x 1

D30*24.5cm

I x 1

D40cm

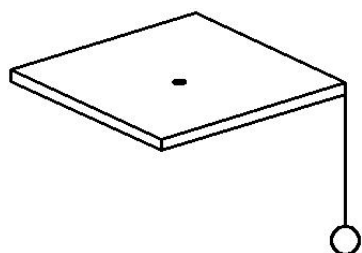
J x 1

D29cm

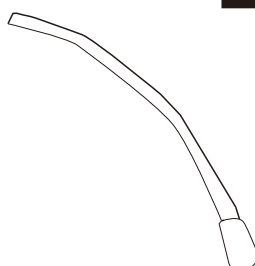
K x 1

L x 1

