

PawHut

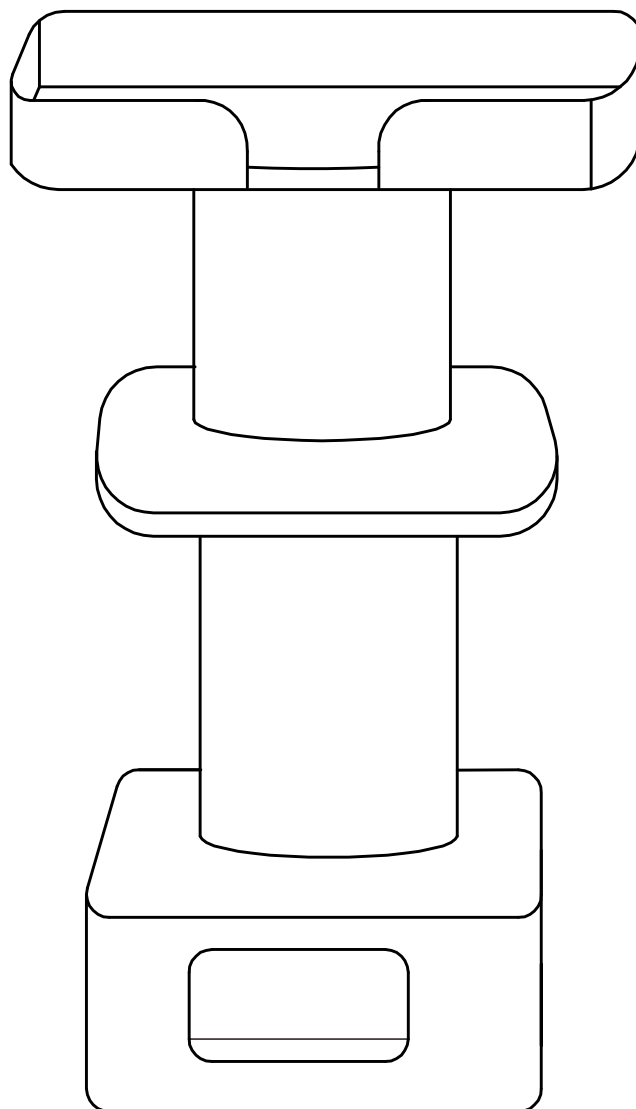

INdha137_GL

D30-372

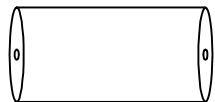
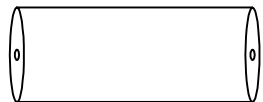
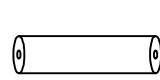
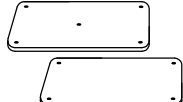
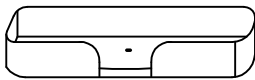
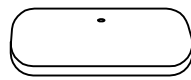
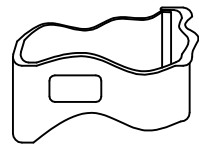
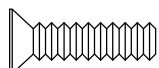
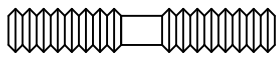

READ AND SAVE THIS INSTRUCTIONS FOR FUTURE USE

ASSEMBLY & INSTRUCTION MANUAL

<p>A x 1</p>  <p>H25CM</p>	<p>B x 1</p>  <p>H35CM</p>	<p>C x 4</p>  <p>H26CM</p>	<p>1 x 2</p>  <p>450x400MM</p>
<p>2 x 1</p>  <p>440x360MM</p>	<p>3 x 1</p>  <p>350x350MM</p>	<p>4 x 1</p> 	
<p>a x 10</p>  <p>M8*40</p>	<p>b x 1</p>  <p>M8*80</p>	<p>c x 1</p> 	

- A x 1**
- B x 1**
- C x 4**
- 1 x 2**
- 2 x 1**
- 3 x 1**
- a x 10**
- b x 1**

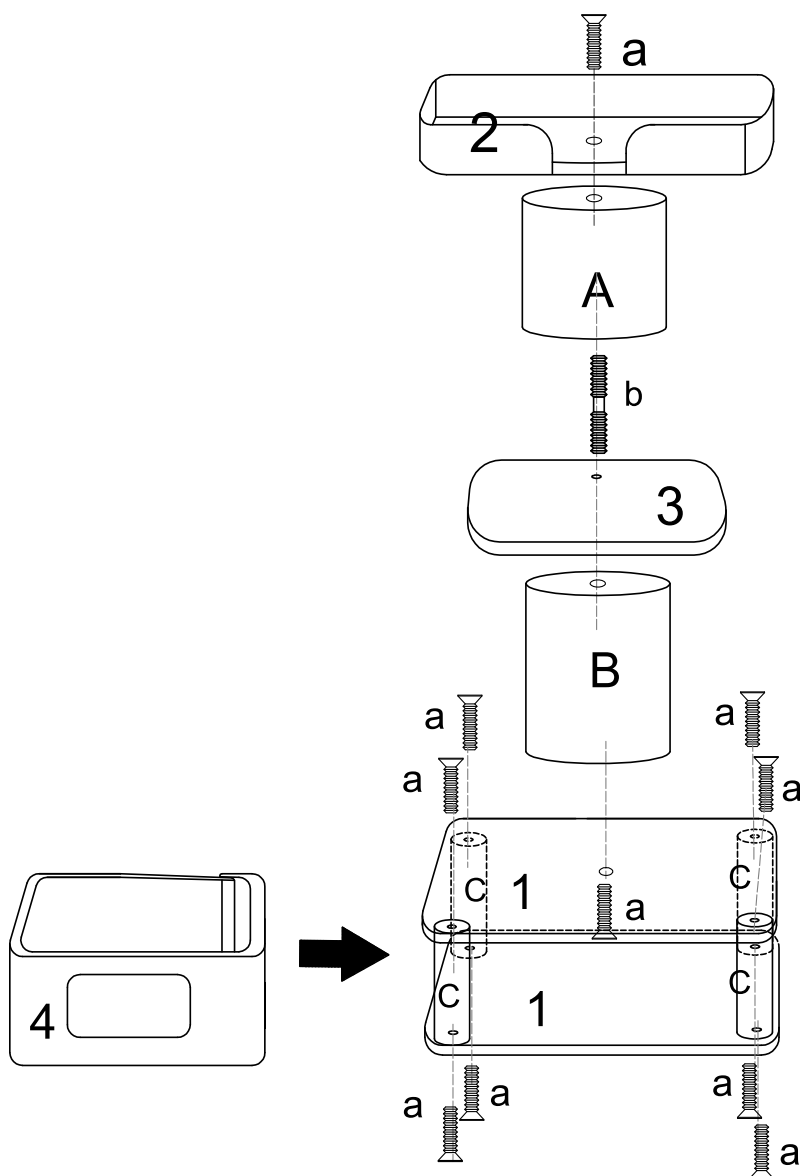

US



001-877-644-9366
customerservice@aosom.com

CA



001-855-537-6088
customerservice@aosom.ca

UK



0044-800-240-4004
enquiries@mhstar.co.uk

DE



0049-(0)40-88307530
service@aosom.de

FR



0033-1-84166106
contact@aosom.fr

ES



0034-931294512
atencioncliente@aosom.es

IT



0039-0249471447
clienti@aosom.it