

PawHut

INdha183_GL

D30-481

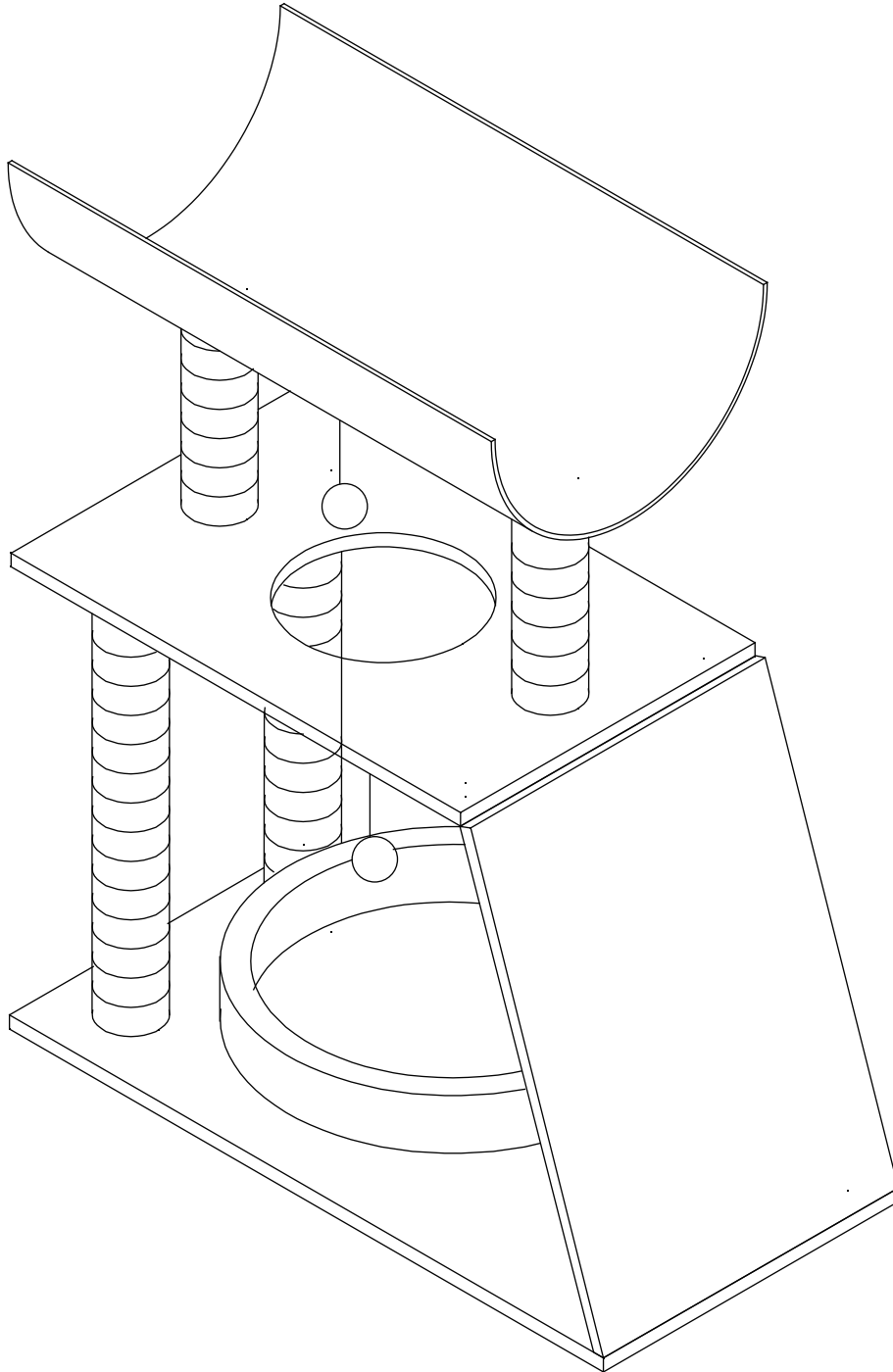

IMPORTANT, RETAIN FOR FUTURE REFERENCE: READ CAREFULLY

ASSEMBLY & INSTRUCTION MANUAL

PARTS

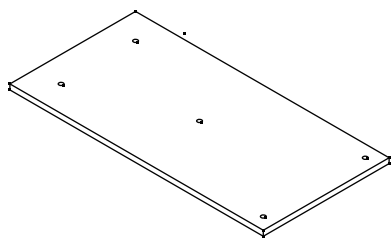

A1 x 1

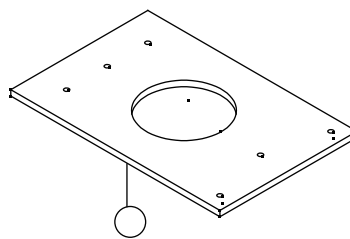

B1 x 1

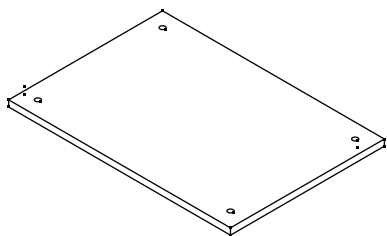

C1 x 1

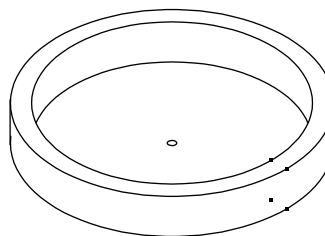

D1 x 1

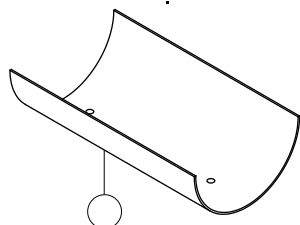

E1 x 1

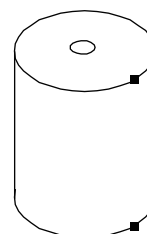

P1 x 1

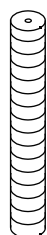

P2 x 2



P3 x 2

HARDWARE

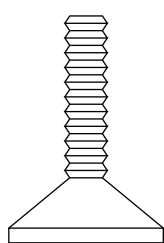

W1 x 9
M8*40
+1(spare)

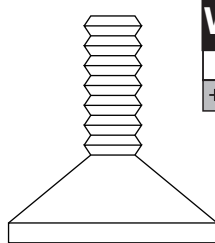

W2 x 8
M8*15
+1(spare)



W3 x 1
M8*53



W4 x 4



W5 x 1

W1 x 3
M8*40

W3 x 1
M8*53

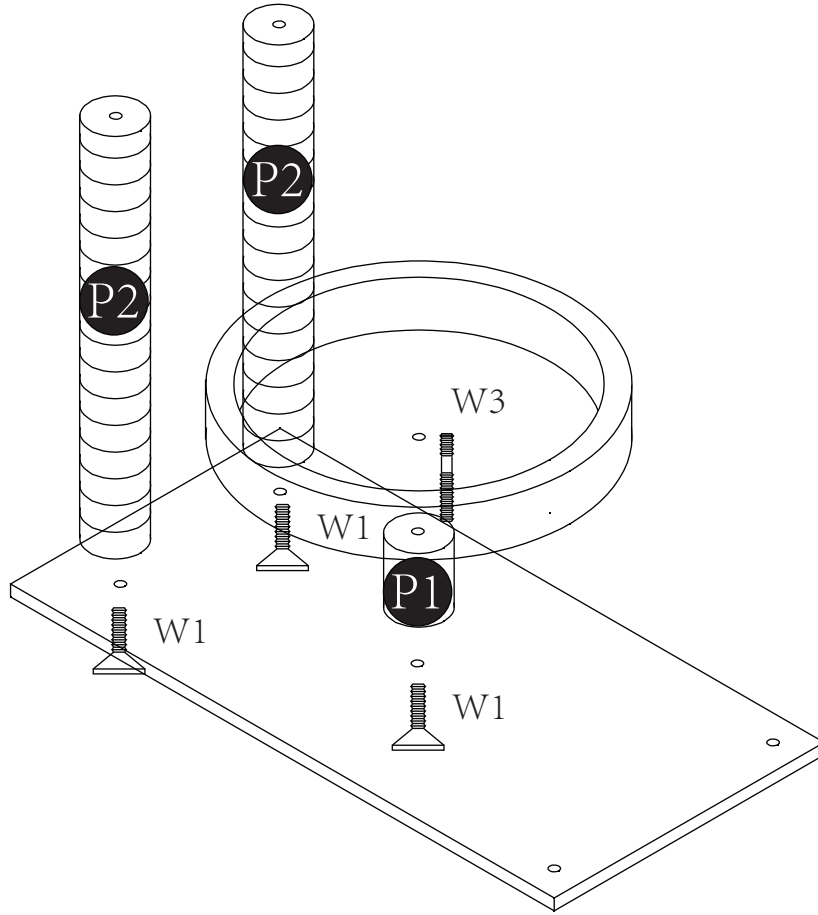

W1 x 2
M8*40

W2 x 8
M8*15

W4 x 4

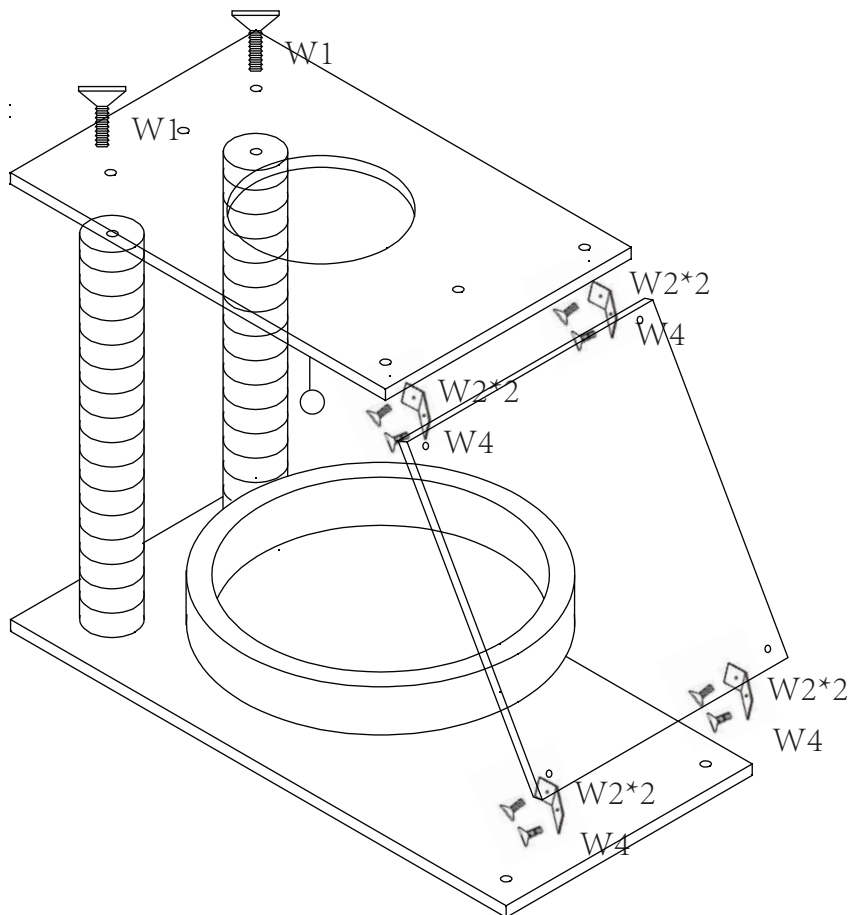

W1 x 4
M8*40

