

# PawHut

INdha193\_GL

**D30-491**

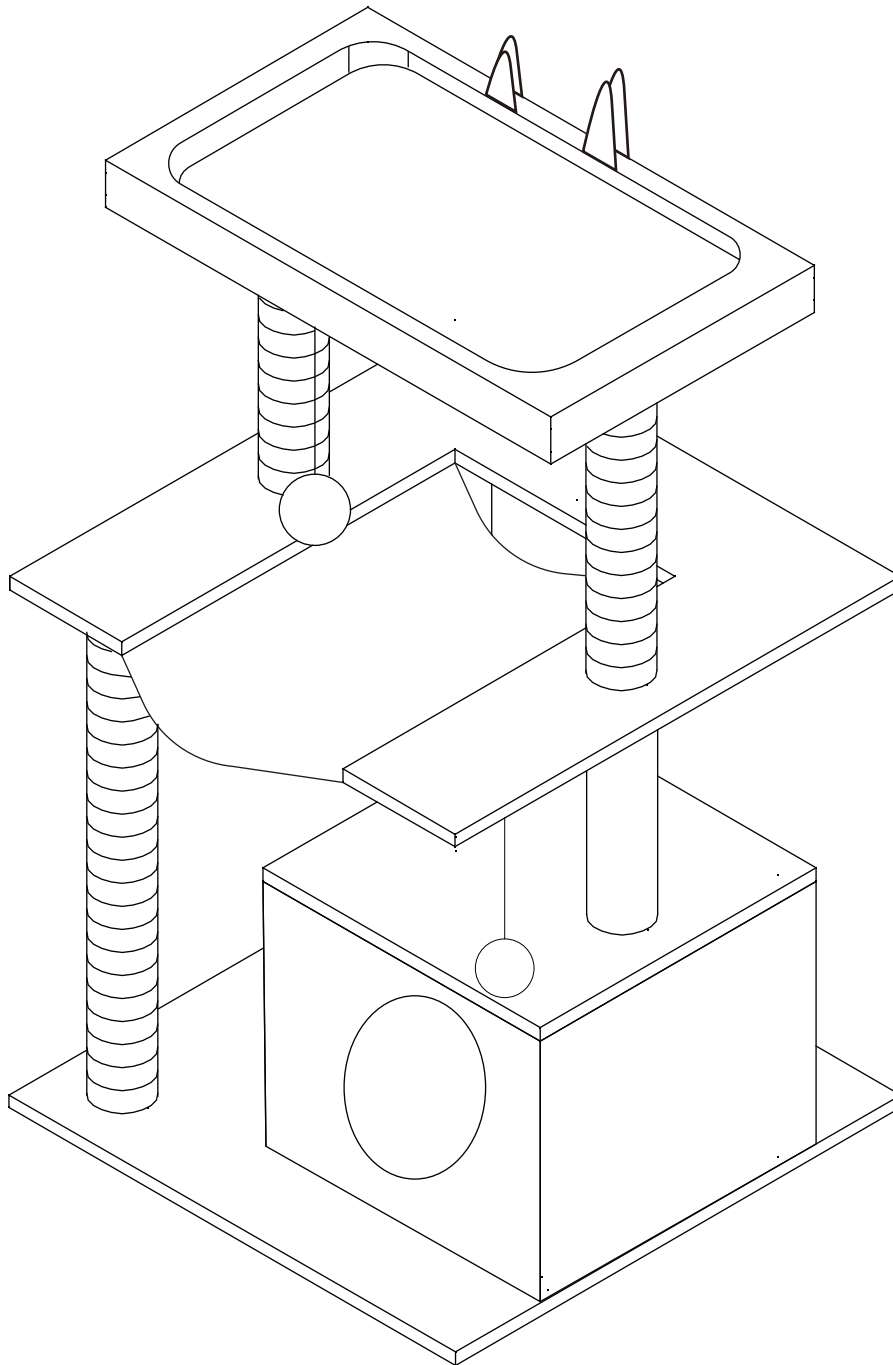

**IMPORTANT, RETAIN FOR FUTURE REFERENCE: READ CAREFULLY**

## ASSEMBLY & INSTRUCTION MANUAL

**PARTS**

**A1** x 1

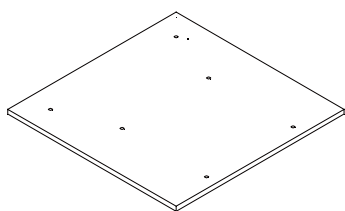

**B1** x 1

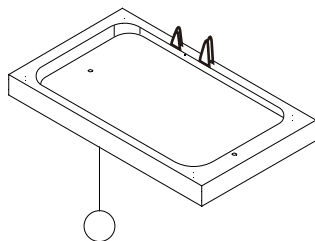

**C1** x 1

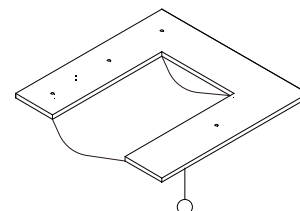

**D1** x 1

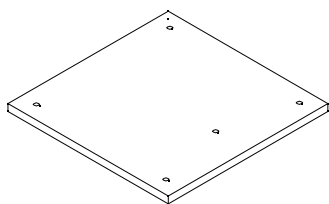

**E1** x 1

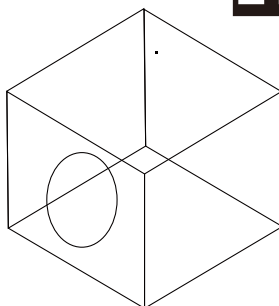

**P1** x 1



**P2** x 1



**P3** x 1



**P4** x 2



**P5** x 4



**HARDWARE**

**W1** x 16  
M8\*40  
+1(spare)

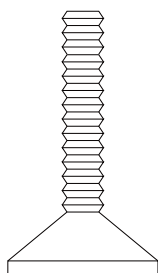

**W2** x 1  
M8\*70



**W3** x 1



