

PawHut

INdhb027V01_GL

D30-191

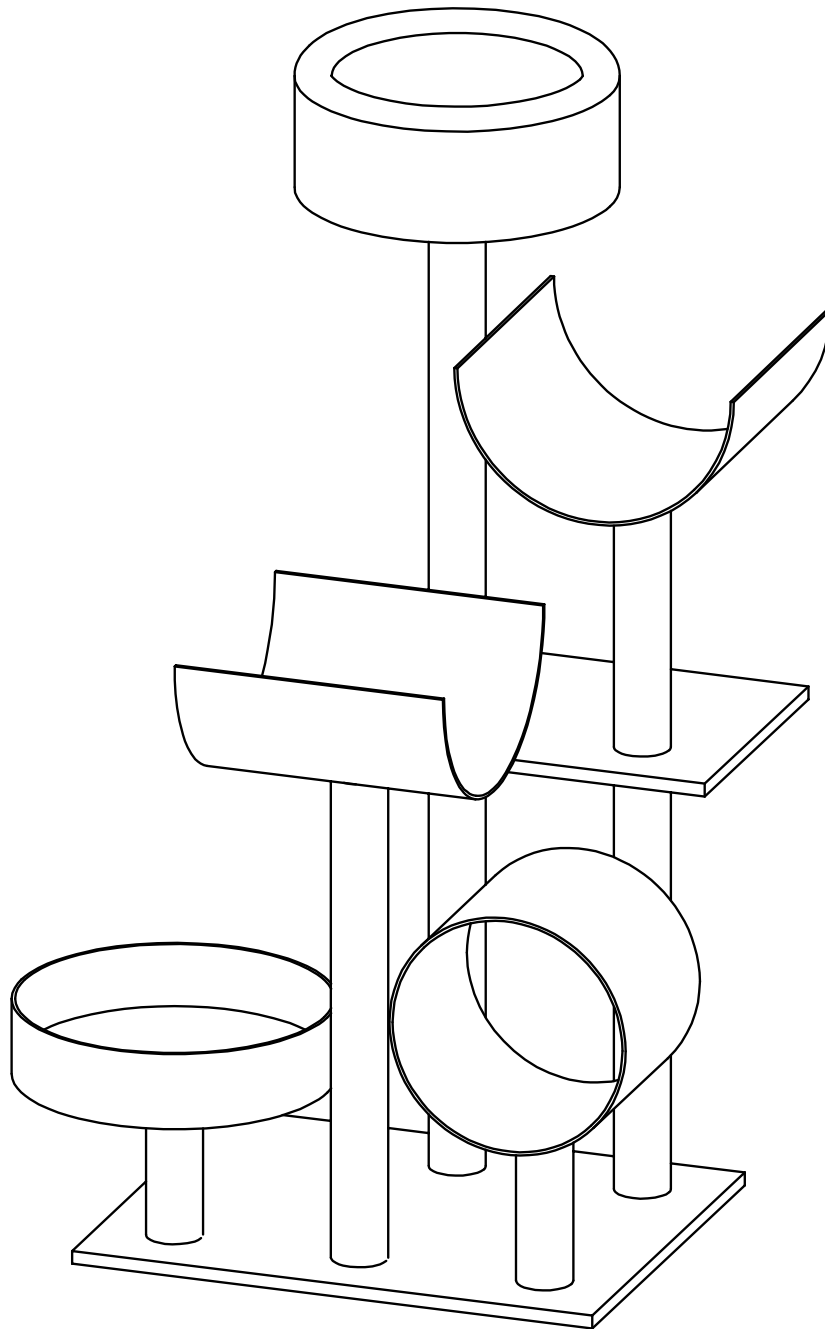

IMPORTANT, RETAIN FOR FUTURE REFERENCE: READ CAREFULLY

ASSEMBLY & INSTRUCTION MANUAL

D x 1

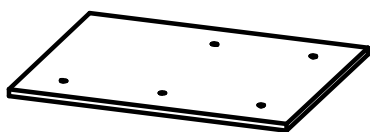

E x 1

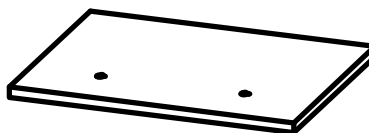

F x 1

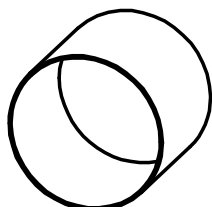

G x 2

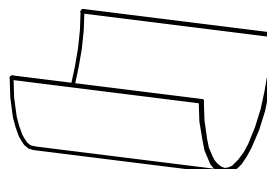

H x 1

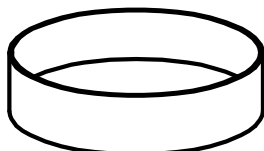

I x 1

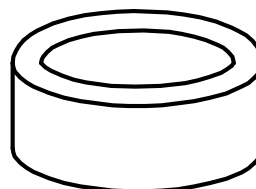

J x 1



K x 1



L x 1



M x 2



N x 1



O x 1





A x 8
M8*40
+1(spare)

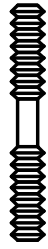

B x 2
M8*80



C x 1

