

# PawHut!

INdhb058\_GL

**D30-377**

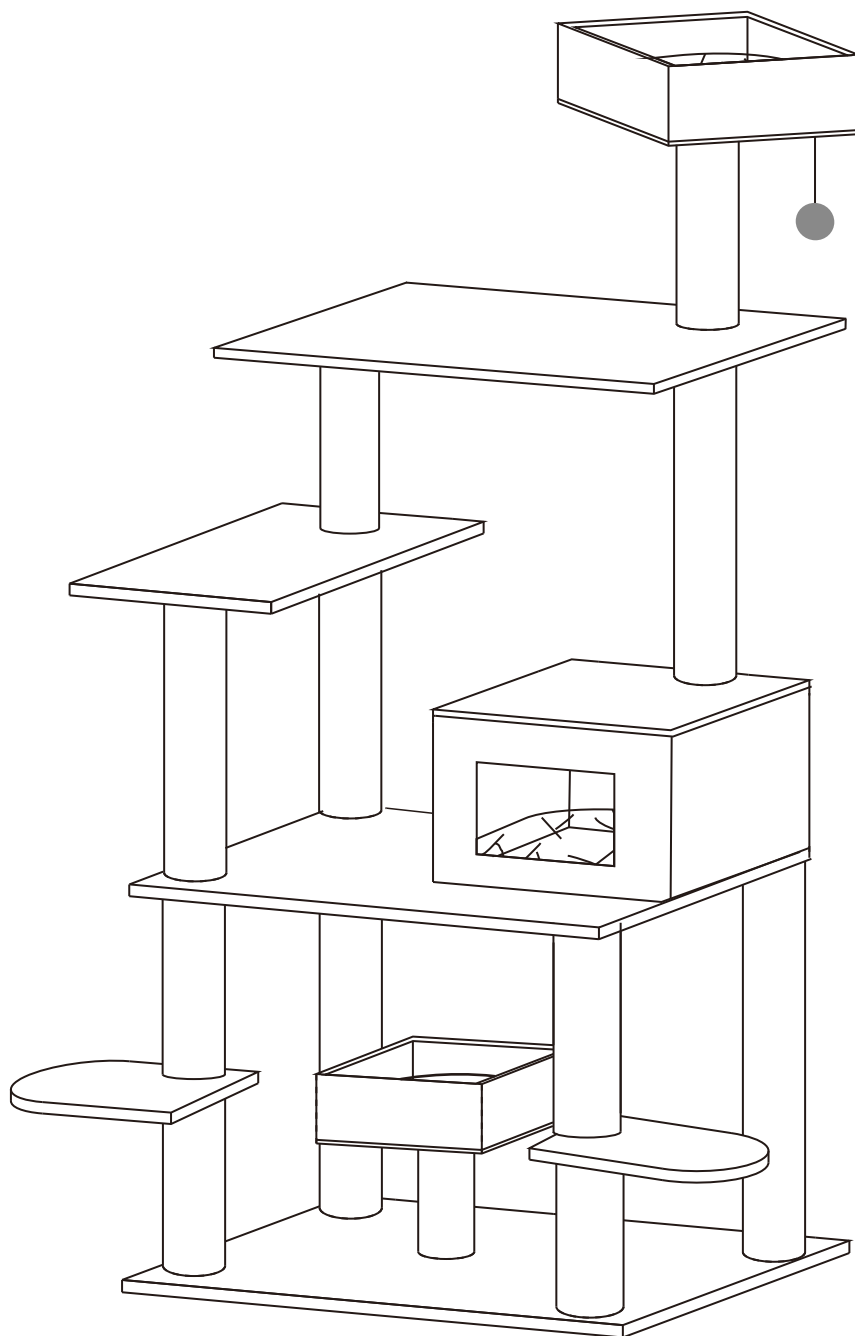

READ AND SAVE THIS INSTRUCTIONS FOR FUTURE USE

## ASSEMBLY & INSTRUCTION MANUAL

**A** x 1

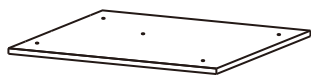

545mm\*545mm\*30mm

**B** x 1

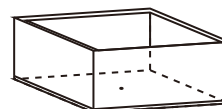

330mm\*330mm\*100mm

**C** x 2



245mm\*175mm\*20mm

**D** x 3



**E** x 1

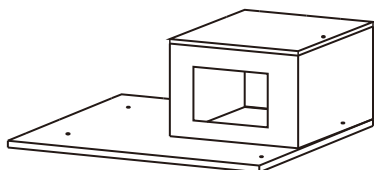

545mm\*545mm\*310mm

**F** x 1



545mm\*305mm\*20mm

**G** x 1



545mm\*305mm\*20mm

**H** x 1

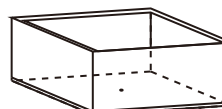

330mm\*330mm\*100mm

**I** x 2



Φ 83mm\*540mm

**J** x 3



Φ 83mm\*450mm

**K** x 3



Φ 83mm\*300mm

**L** x 1



Φ 83mm\*285mm

**M** x 3



Φ 83mm\*225mm

**N** x 12



8mm\*40mm

**O** x 6



8mm\*85mm

**P** x 1

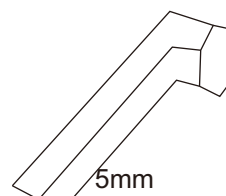

5mm

**A**x 1

**B**x 1

**C**x 2

**D**x 3

**E**x 1

**F**x 1

**G**x 1

**H**x 1

**I**x 2

**J**x 3

**K**x 3

**L**x 1

**M**x 3

**N**x12

**O**x 6

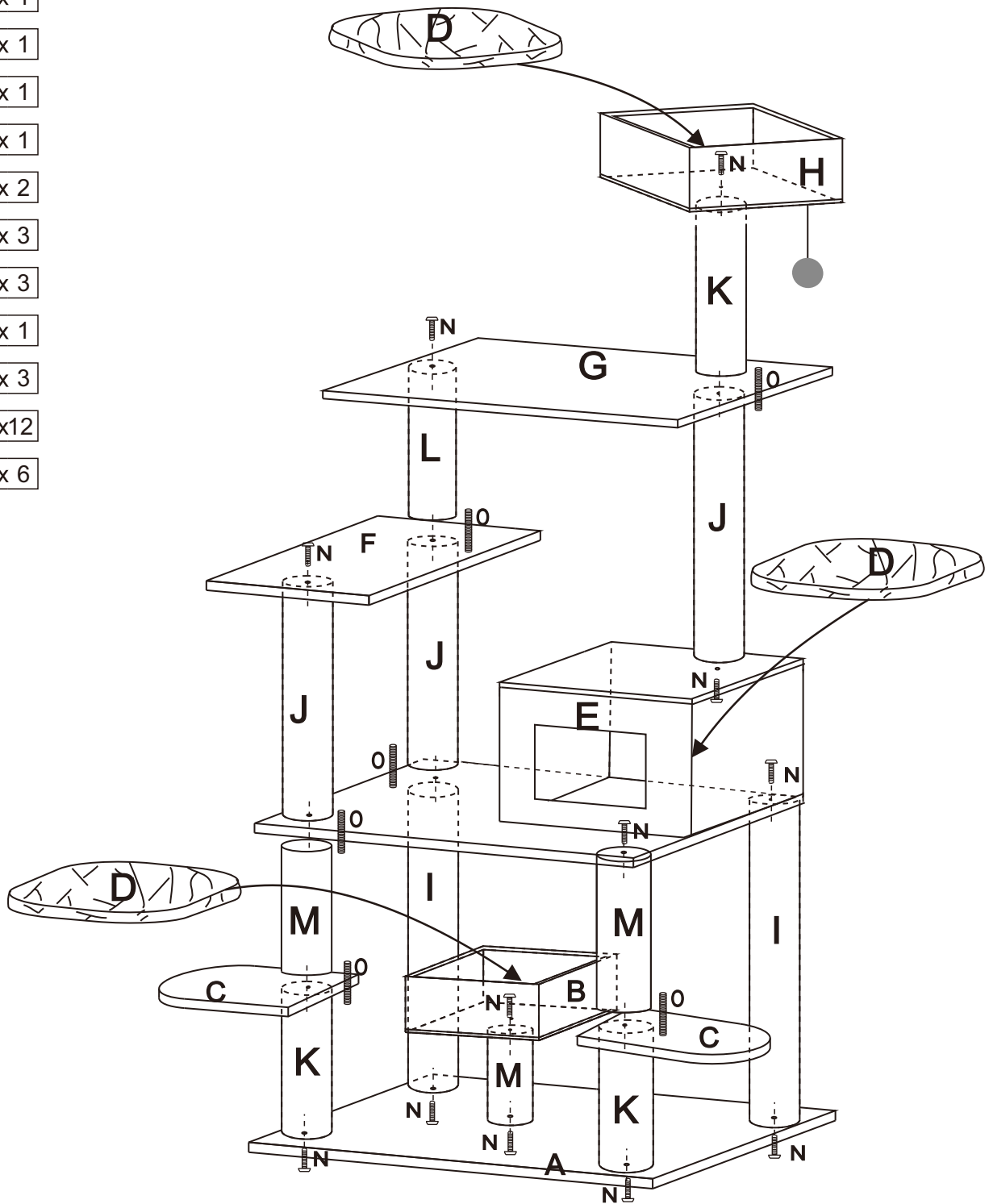

Done

US



001-877-644-9366  
customerservice@aosom.com

CA



001-855-537-6088  
customerservice@aosom.ca

UK



0044-800-240-4004  
enquiries@mhstar.co.uk

DE



0049-(0)40-88307530  
service@aosom.de

FR



0033-1-84166106  
contact@aosom.fr

ES



0034-931294512  
atencioncliente@aosom.es

IT



0039-0249471447  
clienti@aosom.it