

PawHut

INdhc027_GL

D30-407

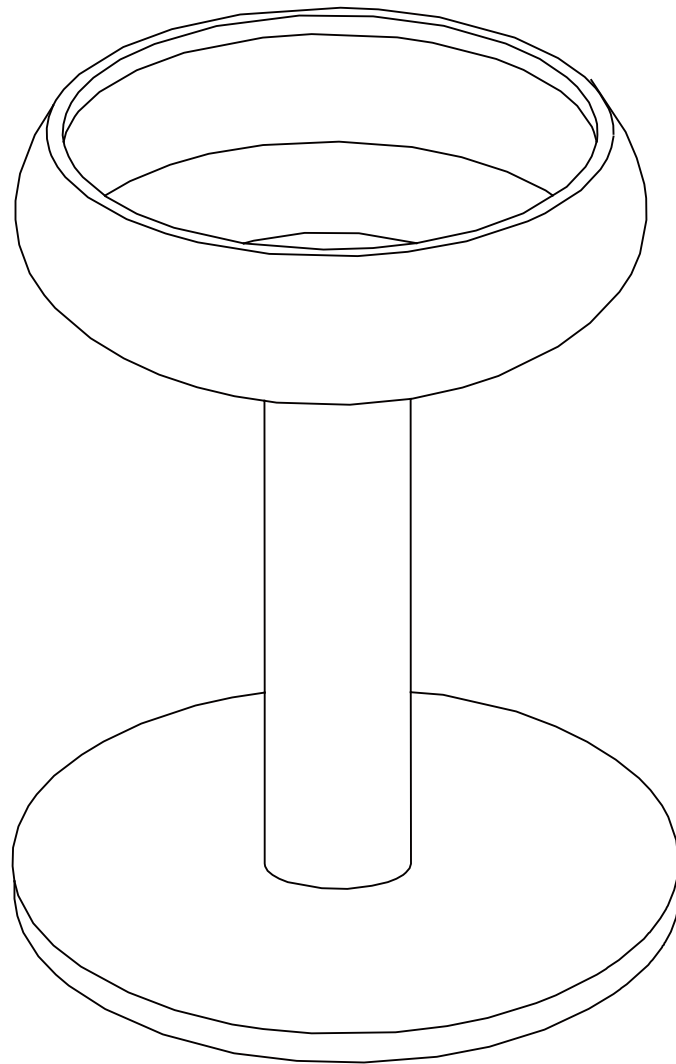

IMPORTANT, RETAIN FOR FUTURE REFERENCE: READ CAREFULLY

ASSEMBLY & INSTRUCTION MANUAL

PARTS

① x1

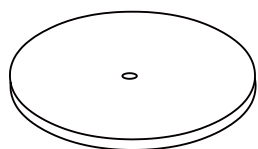

D50*2.5cm

② x1



D45*15cm

③ x1

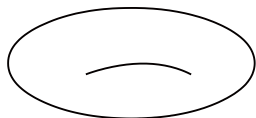

D42cm

④ x1

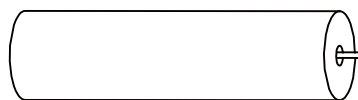

D12*35cm

HARDWARE

A x1

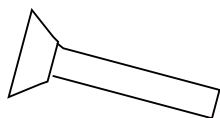

M10*50MM

B x1

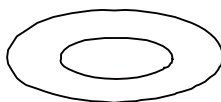

M32MM

C x1

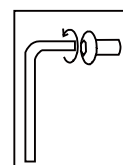

01

① x1

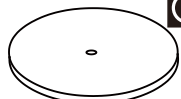

A x1



④ x1

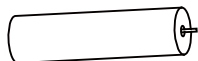

B x1

