

PawHut

INdhc034V01_GL

D30-492

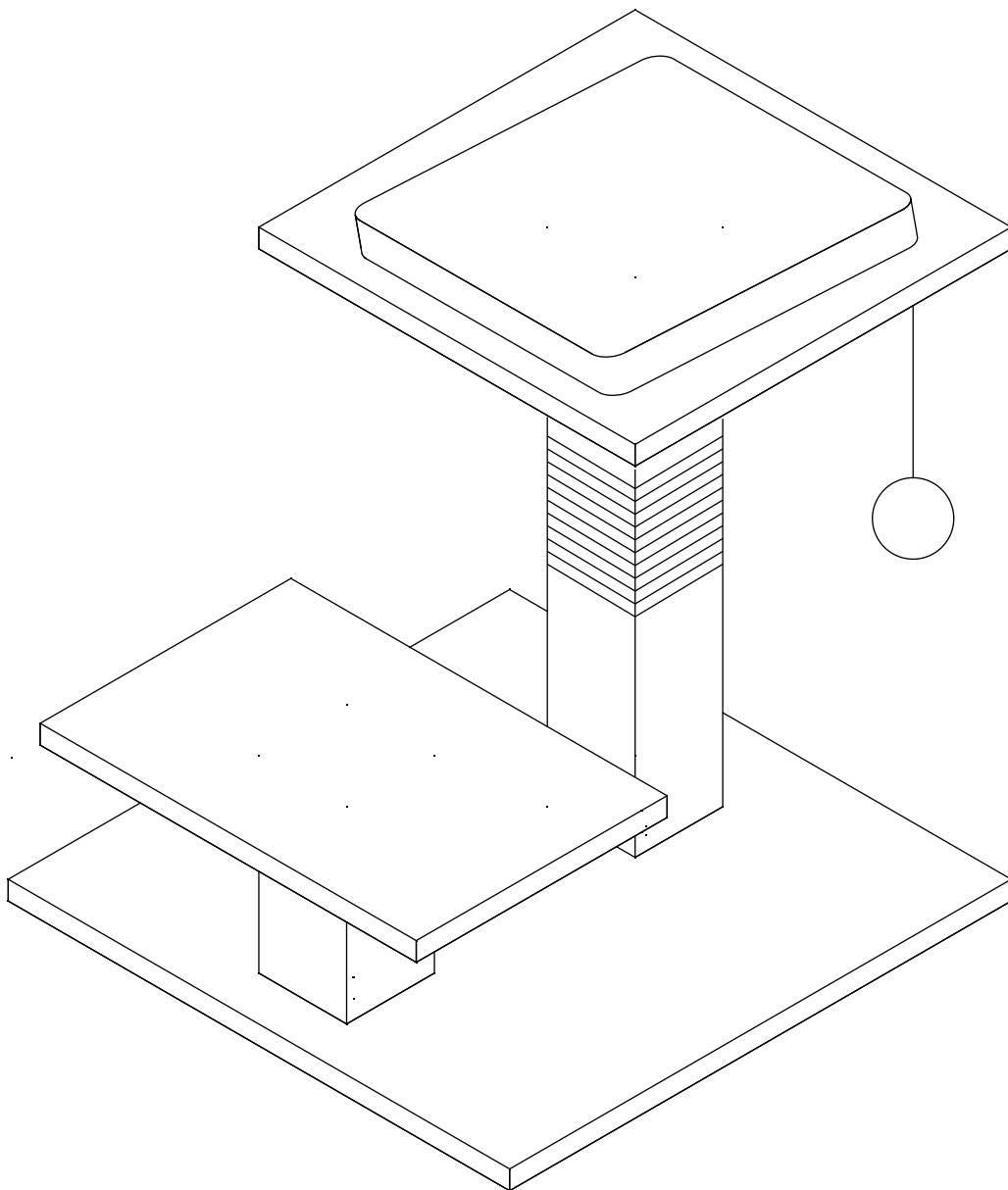

IMPORTANT, RETAIN FOR FUTURE REFERENCE: READ CAREFULLY

ASSEMBLY & INSTRUCTION MANUAL

A1 x 1

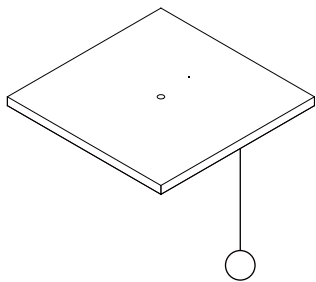

B1 x 1

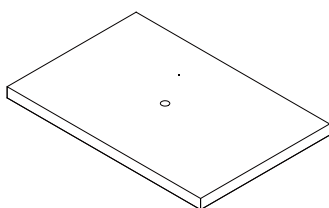

C1 x 1

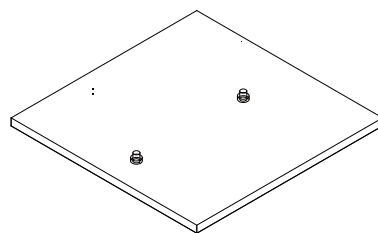

D1 x 1

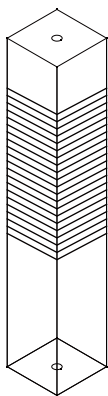

E1 x 1

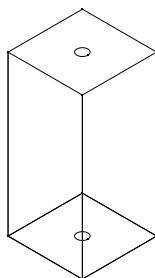

F1 x 4

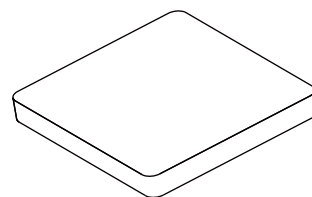
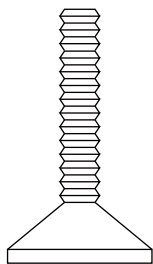
W1 x 4
M8*40

W2 x 1



