

PawHut

INdka008V01_US

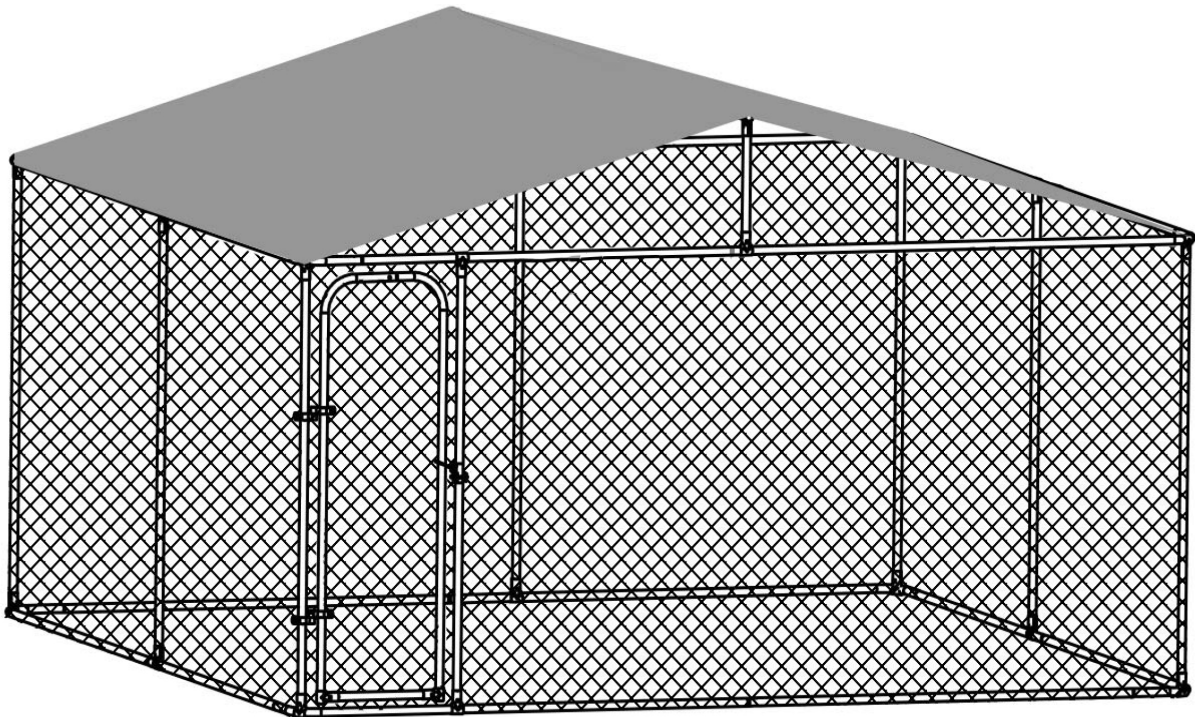























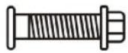



D02-049

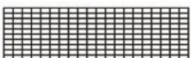

Assembly video please scan the QR code .

READ AND SAVE THIS INSTRUCTION FOR FUTURE USE

ASSEMBLY INSTRUCTION

PART NO.	DIMENSION	STYLE PIC	QUANTITY
①	250+1310mm		8
②	1765mm		4
③	1765mm		8
④	497mm		2
⑤	850 mm		8
⑥	1375 mm		2
⑦	1210 mm		4
⑩	1375 mm		1
A	295+1700mm		1
B	325 +1700mm		1
C	497mm		1
D			60
E			2
F			2
G			1
H			30
I			4
J			44
K	Φ2x180mm		280
L	Φ8x1630 mm		2
M	Φ 8x1830 mm		2
N			1
O			1
P			16
Q			1
R			1
S			1
T			1
U			1

01

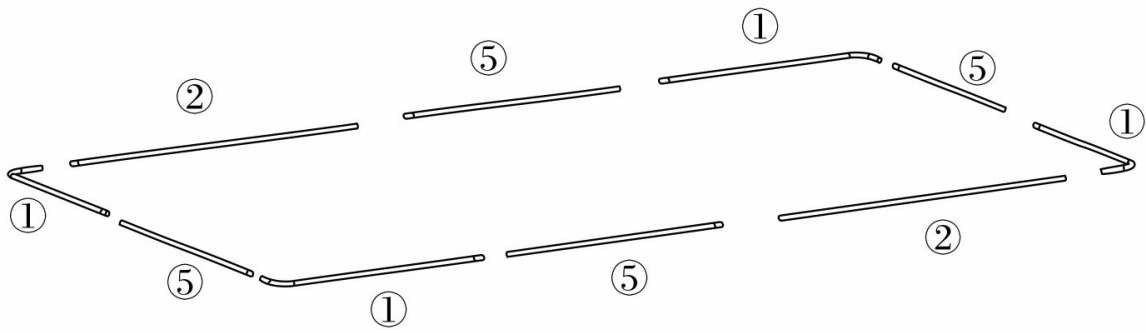

x2

02

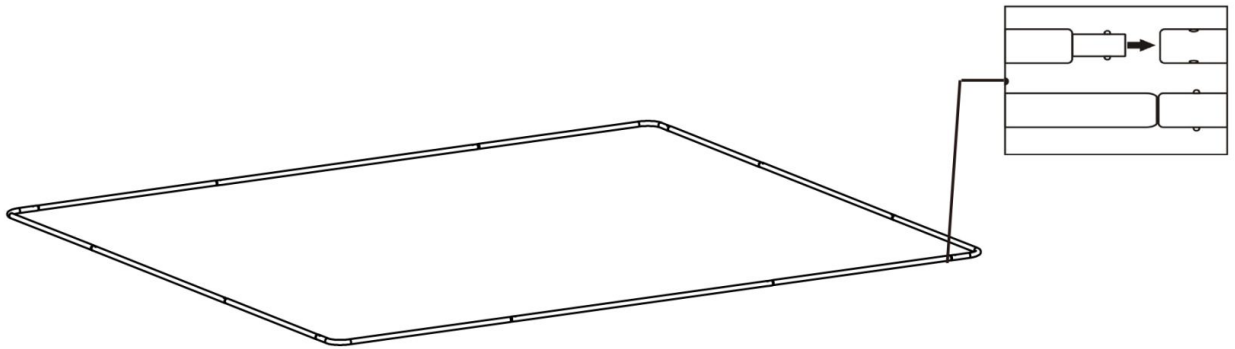

Repeat this step twice for the top and bottom frame

x2

03

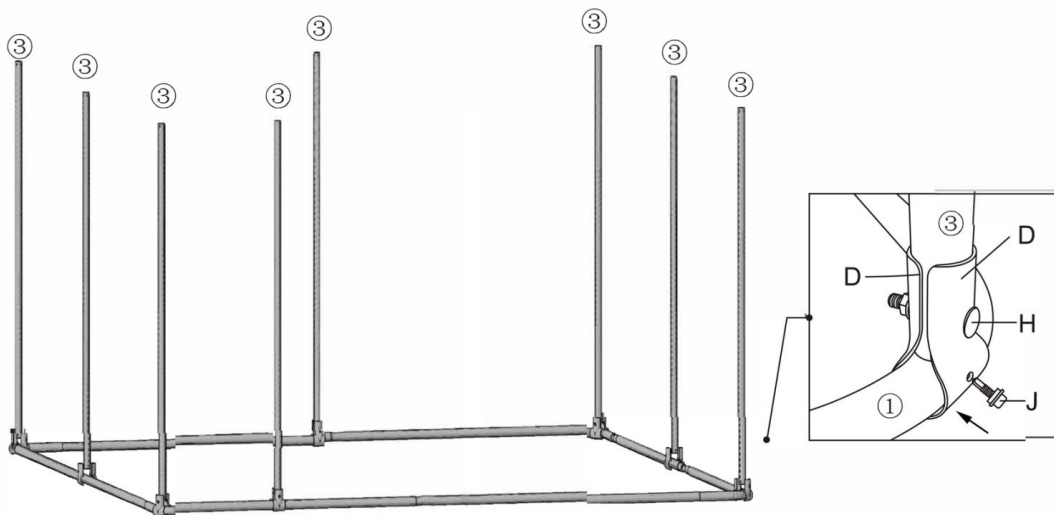

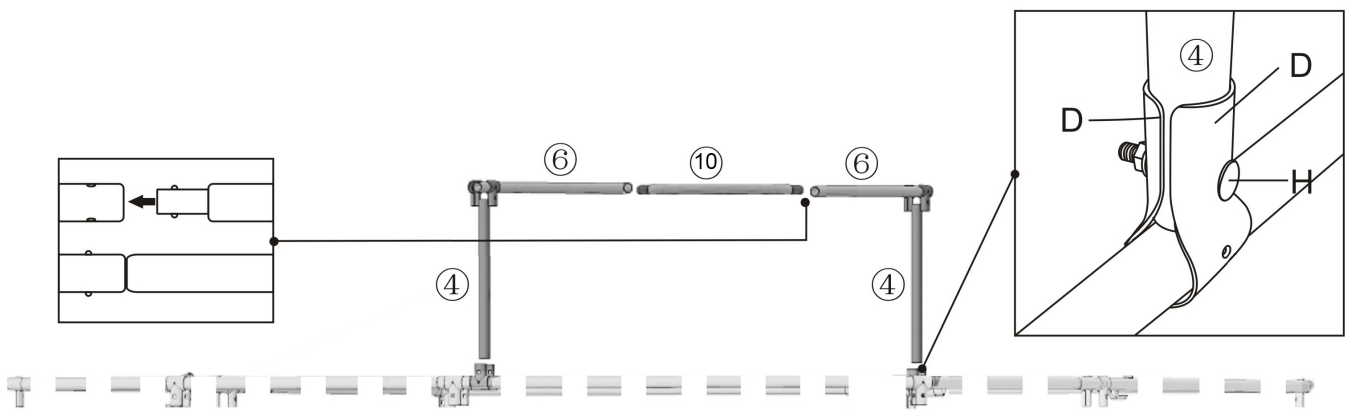
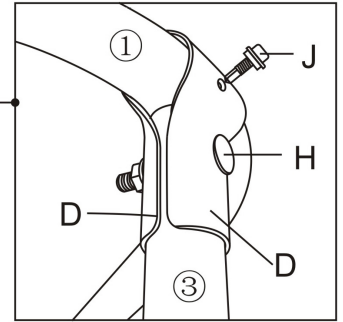
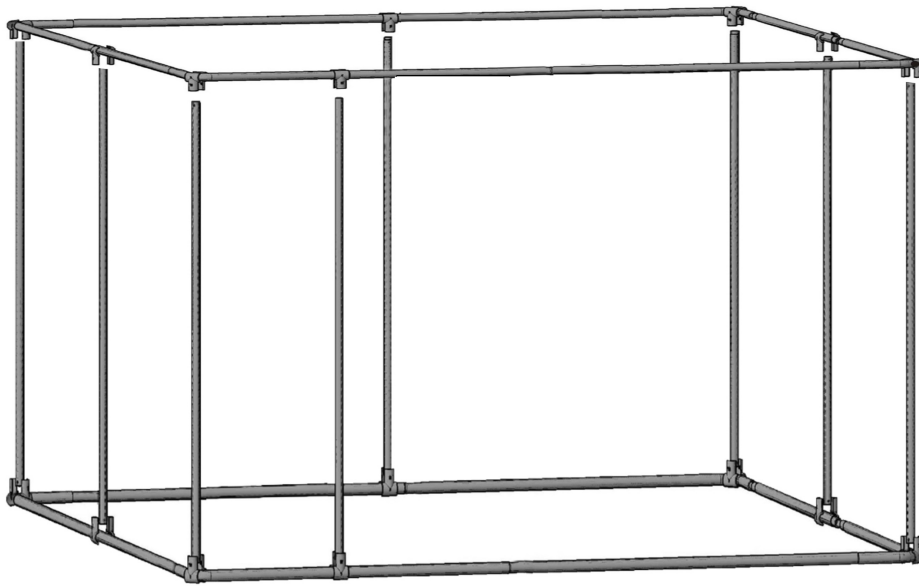

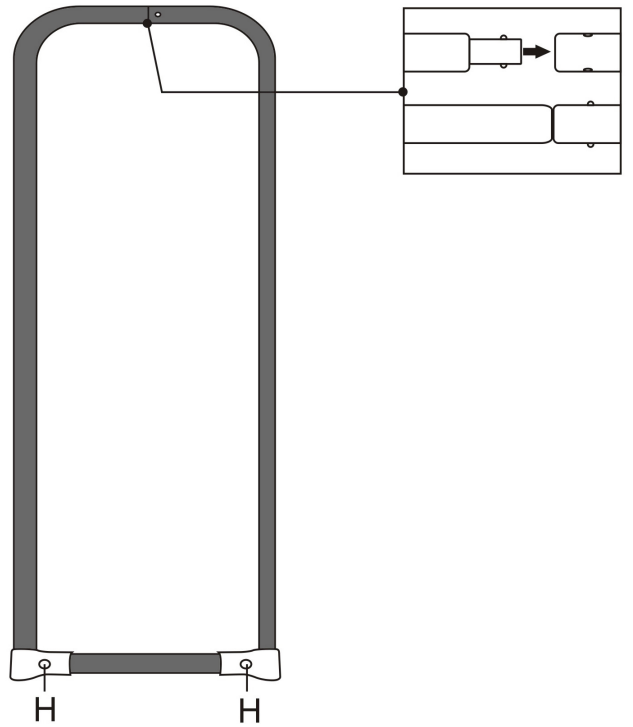
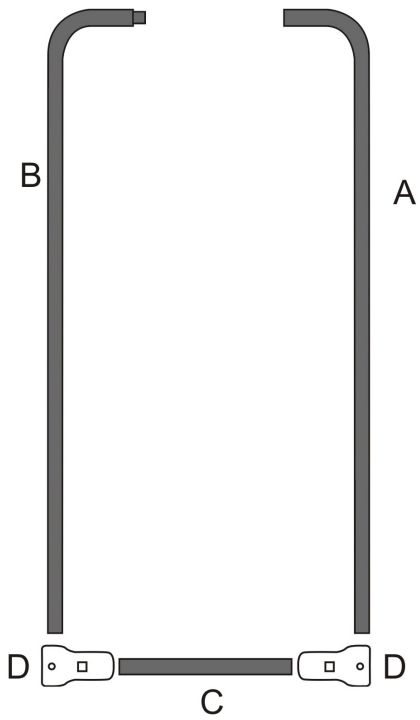
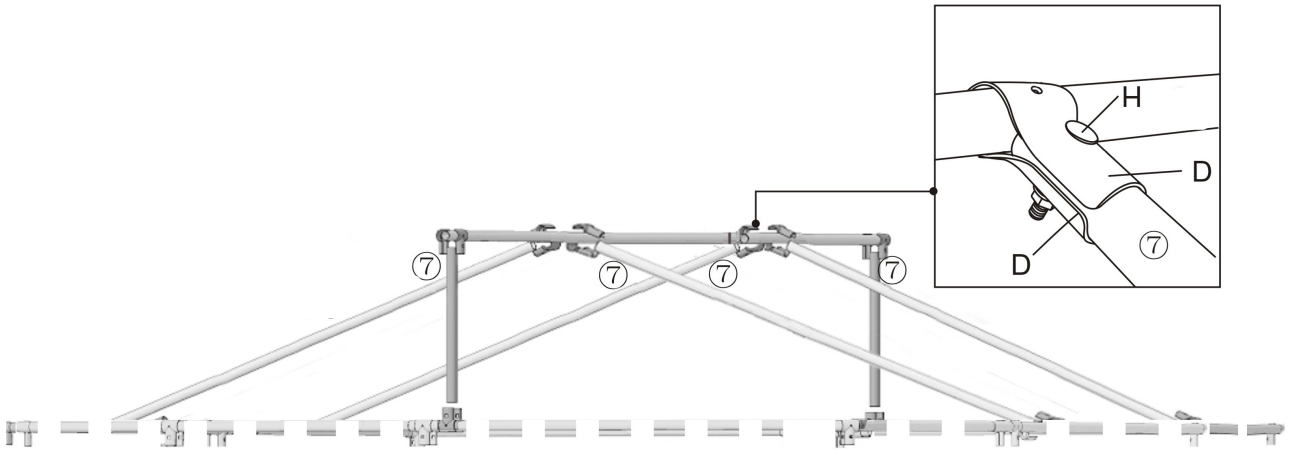

9

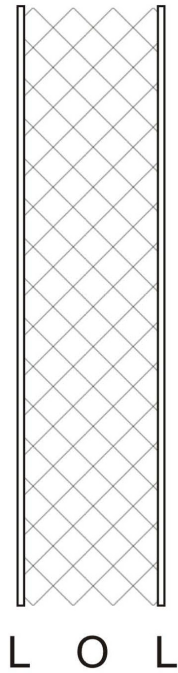

10

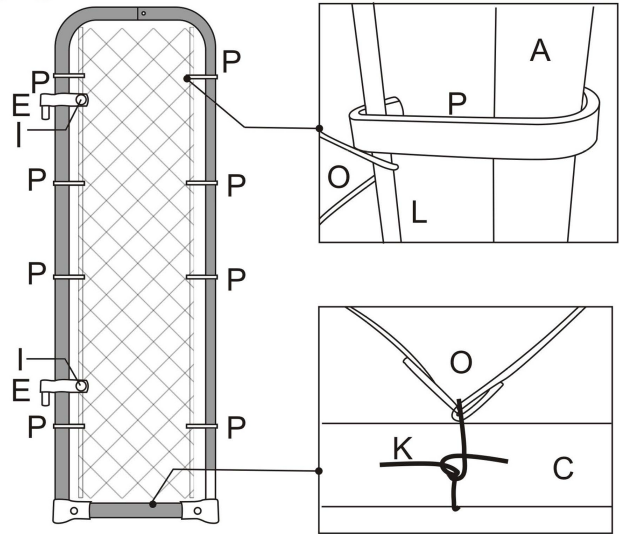

Install the chain-link mesh onto the gate frame. Then insert the two round rod into the edges of the chain-link mesh, and then use 4 pairs of hooks to fix the round rods and tube. Finally, use the bind-wire to fix the chain-link mesh to the gate frame to make the gate rigid and strong. (Note: loosen the clips on the post to allow adjustment and exact fit)

Done

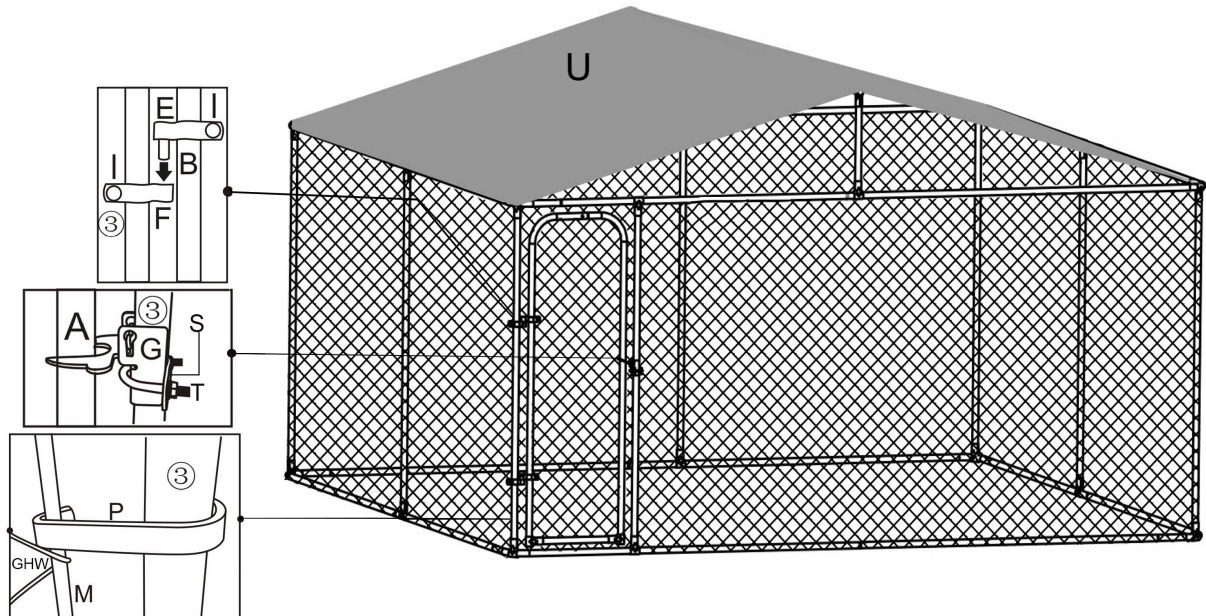

Use the door hinges (and the big set of screws) to fix the door to the frame. Then install the security-lock on the dog run. Tie bind wire to fix the top and bottom of the gate with chain-link mesh and make the gate safe and strong by using the screw gun with the drill to put a self-tapping screw through the pilot holes in the tubes-this also makes the dog run stronger.

Installing the chain link mesh

Start by unrolling the compressed chain-link mesh roll on the ground and extending it. Then roll it again. Insert 1 piece of round rod into the edge of the chain-link mesh roll, and then hook the round rod with the door post - another person is then required to unroll the chain-link mesh around the frame of the dog run.

If the chain-link mesh is too long, remove some of the wire at the desired length (at least 15-20 cm from the door). Insert another round rod piece into the edge of the chain-link mesh to tighten the chain-link mesh to a good fit. Attach the hooked round rod to the frame. To secure the top and the bottom of the dog run - tie some binding wire to fix the chain-link mesh to the frame. Finally, ensure that the clips are fixed tightly and securely to the frame by using the self-tapping screws. Now your large dog run is complete and ready for your dog.

notice

1. Need 2 people at least when you assemble to avoid the damage of steel tube.
2. Do not use this cage unless all bolts, screws and knobs are firmly secured.
3. Please use it on a flat hard ground.
4. No climbing and no revision on product.
5. Caution, hands pinching.



Warning Tip:

- A: Guarantee every post upright
- B: Fasten J with R and electric tool in the right direction.
- C: Make sure every J assembled correctly before put your kennel in use.

