

PawHut!

INdkd011_US_CA

D02-048V04

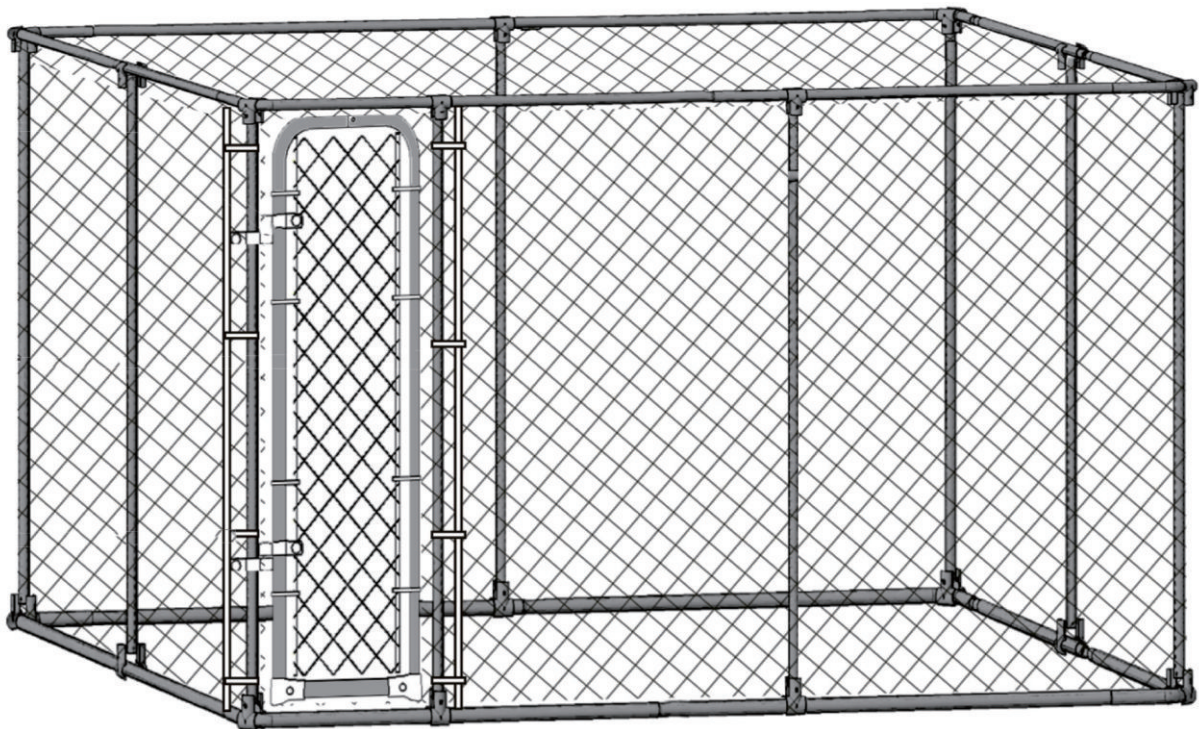

EN_IMPORTANT, RETAIN FOR FUTURE REFERENCE: READ CAREFULLY.







FR_IMPORTANT: A LIRE ATTENTIVEMENT ET À CONSERVER POUR CONSULTATION ULTÉRIEURE.

ES_IMPORTANTE, LEA Y GUARDE PARA FUTURAS REFERENCIAS.

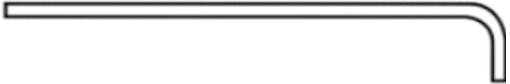
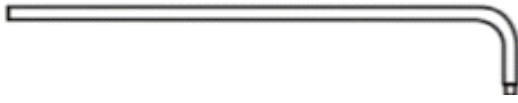
DE_WICHTIG! SORGFÄLTIG LESEN UND FÜR SPÄTER NACHSCHLAGEN AUFBEWAHREN.

IT_IMPORTANTE! CONSERVARE IL PRESENTE MANUALE PER FUTURO RIFERIMENTO E LEGGERLO ATTENTAMENTE.

**BOX
1-2**









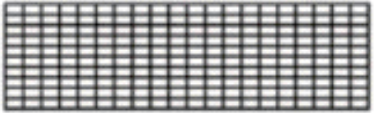
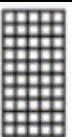













Model	Picture	QTY
A		1
B		1
C		1
1		8
2		8
3		9
5		8

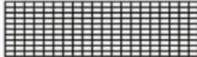

Hardware Kit

**BOX
2-2**

Model	Picture	QTY
N		1
O		1

PART NO.	DIMENSION	STYLE PIC	QUANTITY
①	250+1310mm		8
②	1765mm		8
③	1765mm		9
⑤	850 mm		8
A	295+1700mm		1
B	325 +1700mm		1
C	497mm		1
D			40
E			2
F			2
G			1
H			20
I			4
J			25
K	Φ2x180mm		1
L			1
N			1
O			1
Q			1
R			1
S			1
T			1

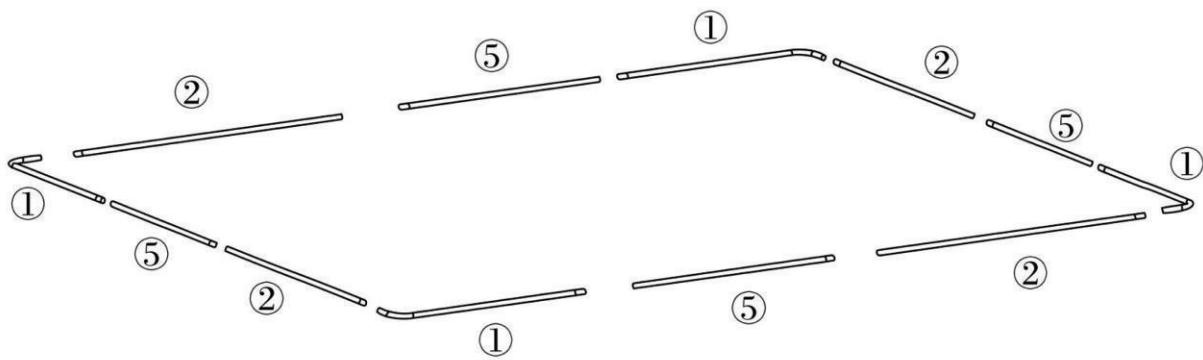

x2

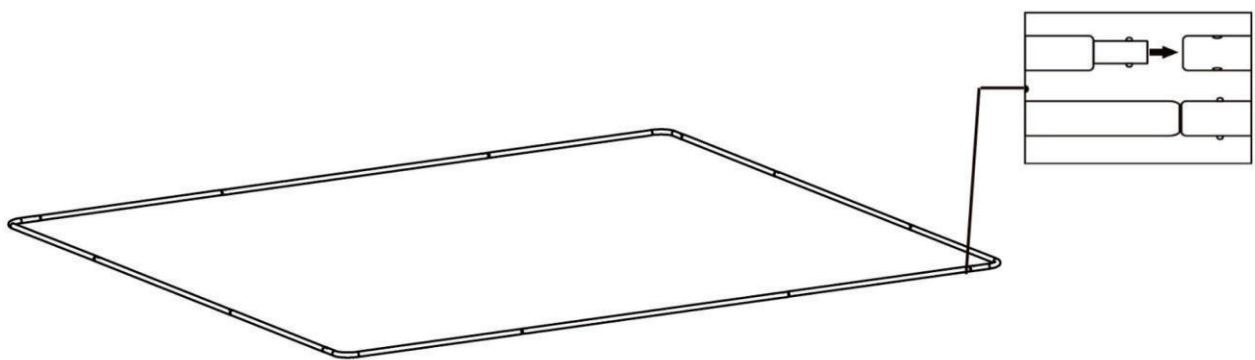

Repeat this step twice for the top and bottom frame

x2

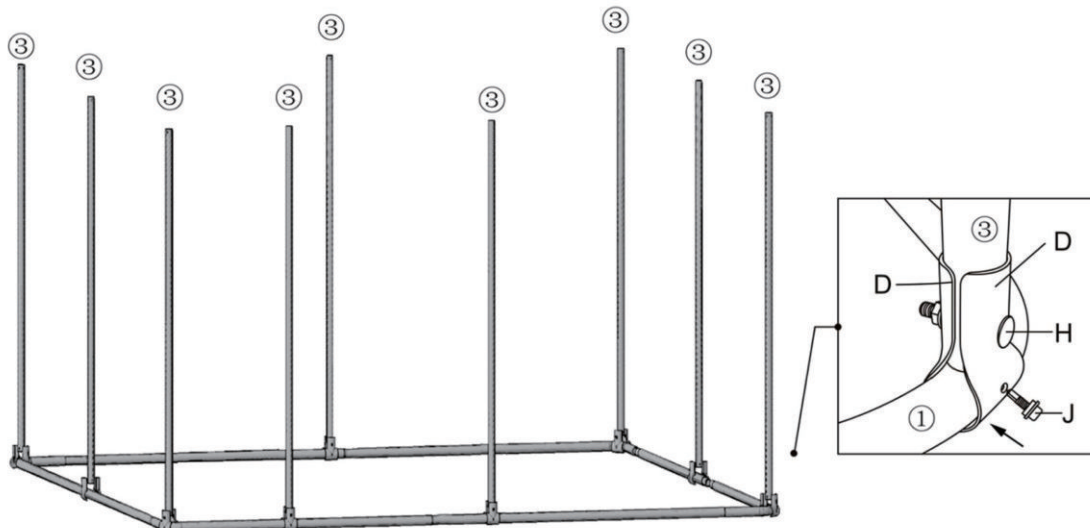

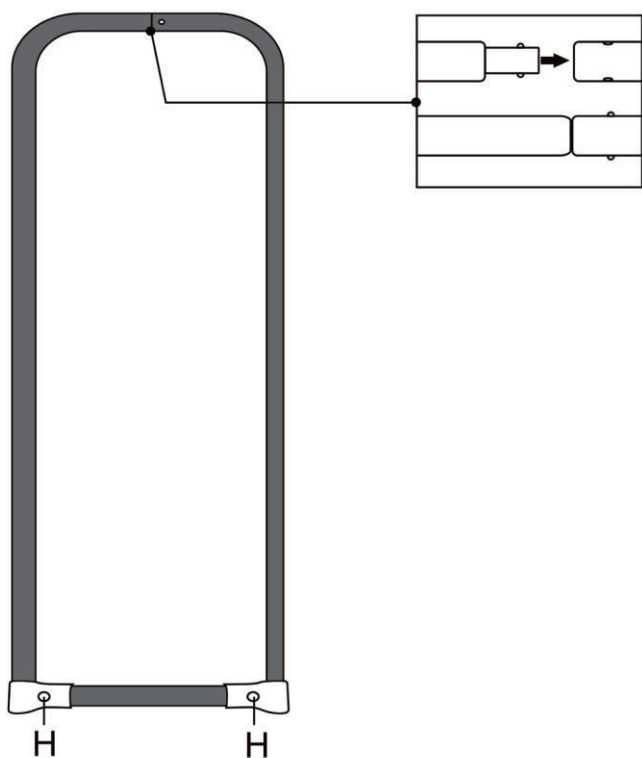
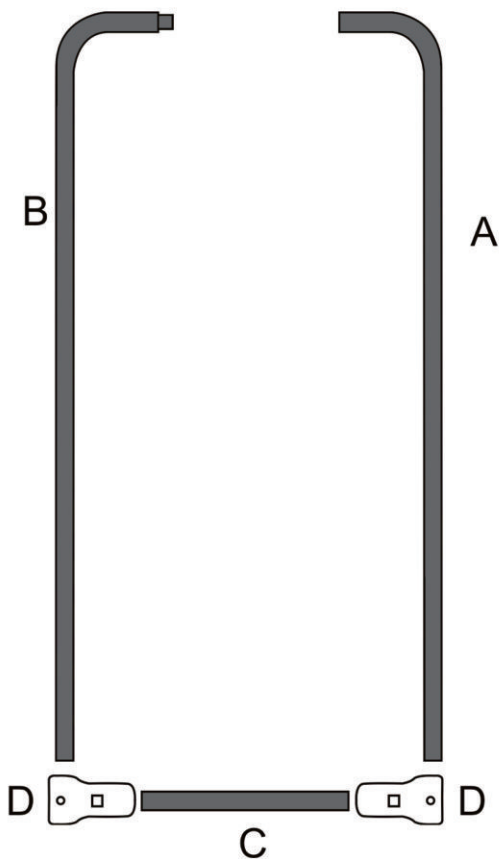
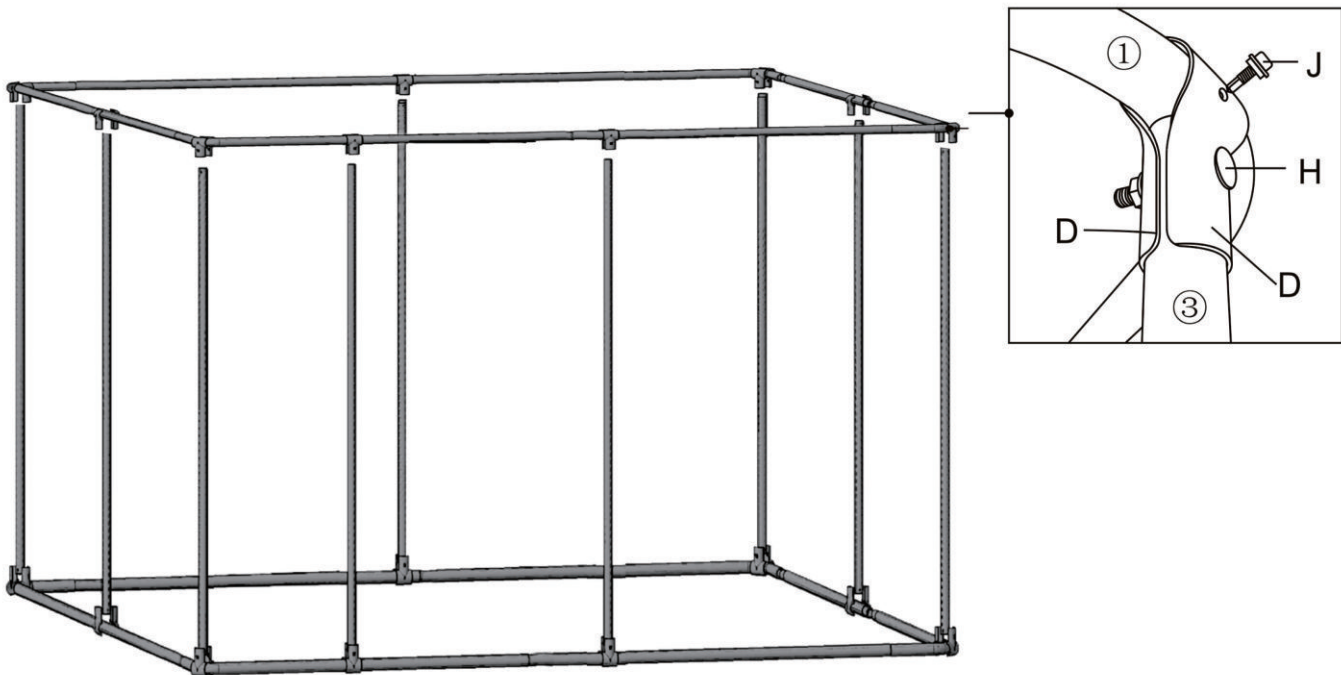

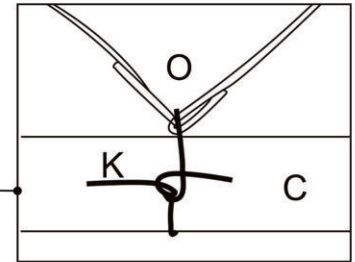
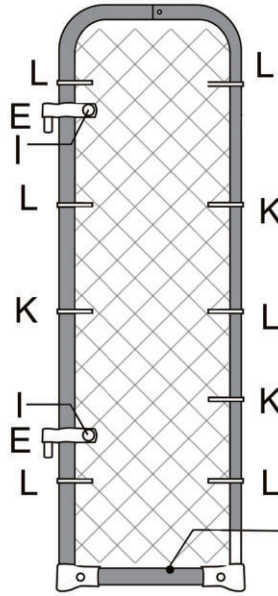

Install the chain-link mesh onto the gate frame. Then insert the two round rod into the edges of the chain-link mesh, and then use 4 pairs of hooks to fix the round rods and tube. Finally, use the bind-wire to fix the chain-link mesh to the gate frame to make the gate rigid and strong. (Note: loosen the clips on the post to allow adjustment and exact fit)

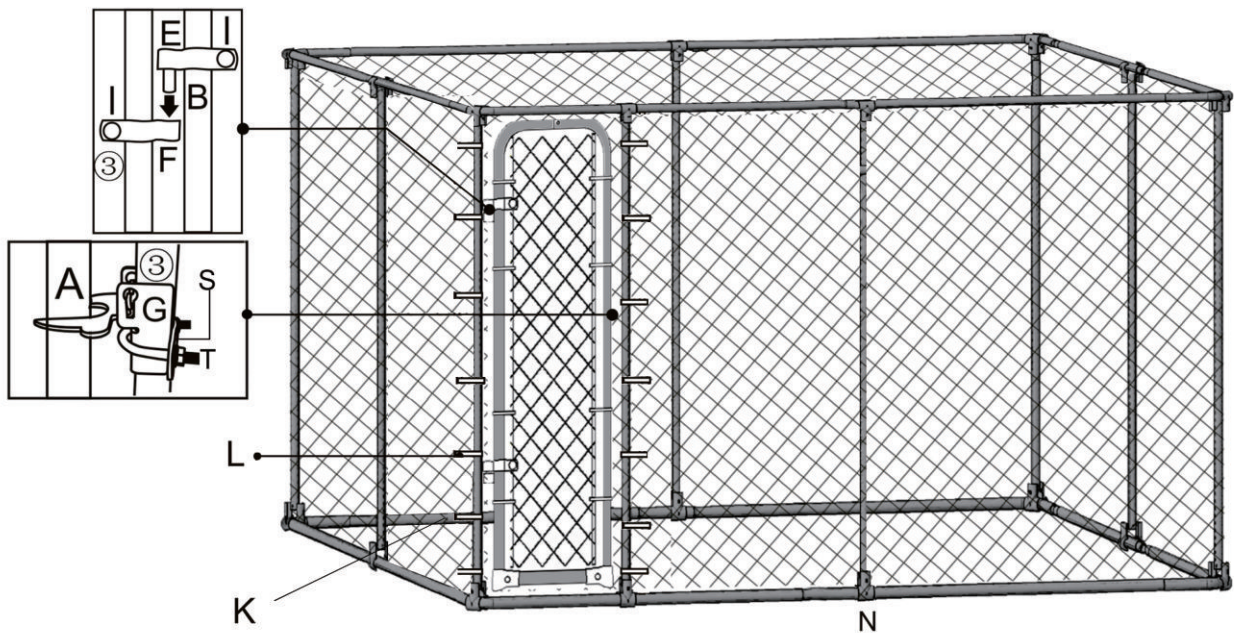

Use the door hinges (and the big set of screws) to fix the door to the frame. Then install the security-lock on the dog run. Tie bind wire to fix the top and bottom of the gate with chain-link mesh and make the gate safe and strong by using the screw gun with the drill to put a self-tapping screw through the pilot holes in the tubes-this also makes the dog run stronger.

Installing the chain link mesh

Start by unrolling the compressed chain-link mesh roll on the ground and extending it. Then roll it again. Insert 1 piece of round rod into the edge of the chain-link mesh roll, and then hook the round rod with the door post - another person is then required to unroll the chain-link mesh around the frame of the dog run.

If the chain-link mesh is too long, remove some of the wire at the desired length (at least 15-20 cm from the door). Insert another round rod piece into the edge of the chain-link mesh to tighten the chain-link mesh to a good fit. Attach the hooked round rod to the frame. To secure the top and the bottom of the dog run - tie some binding wire to fix the chain-link mesh to the frame. Finally, ensure that the clips are fixed tightly and securely to the frame by using the self-tapping screws. Now your large dog run is complete and ready for your dog.

notice

1. Need 2 people at least when you assemble to avoid the damage of steel tube.
2. Do not use this cage unless all bolts, screws and knobs are firmly secured.
3. Please use it on a flat hard ground.
4. No climbing and no revision on product.
5. Caution, hands pinching.



Warning Tip:

- A: Guarantee every post upright
- B: Fasten J with R and electric tool in the right direction.
- C: Make sure every J assembled correctly before put your kennel in use.

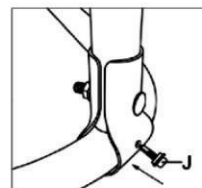





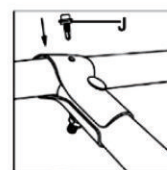

Warning Tip:

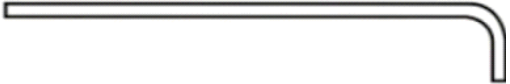
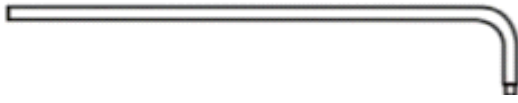
- A: For safety consideration please make sure to find part J from 2/2 carton and fasten down the kennel before you put it in use.
- B: Guarantee every post upright.
- C: Fasten J with R and electric tool in the right direction.
- D: Make sure every J assembled correctly before put your kennel in use.



**BOX
1-2**









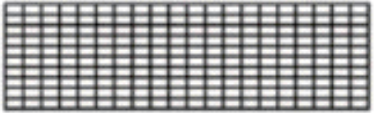
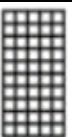













Model	Picture	QTY
A		1
B		1
C		1
1		8
2		8
3		9
5		8

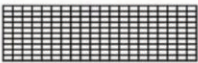

Hardware Kit

**BOX
2-2**

Model	Picture	QTY
N		1
O		1

NO PIÈCE	DIMENSION	IMAGE	QUANTITÉ
①	250+1310mm		8
②	1765mm		8
③	1765mm		9
⑤	850 mm		8
A	295+1700mm		1
B	325 +1700mm		1
C	497mm		1
D			40
E			2
F			2
G			1
H			20
I			4
J			25
K	Φ2x180mm		1
L			1
N			1
O			1
Q			1
R			1
S			1
T			1

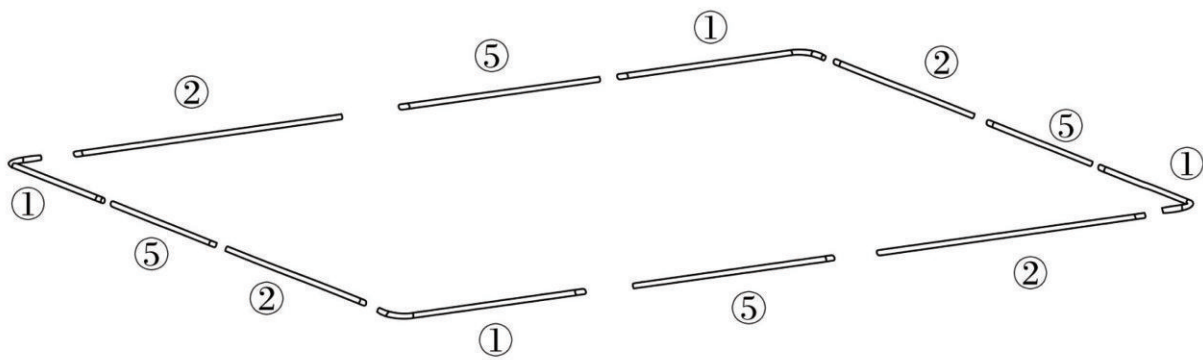

x2

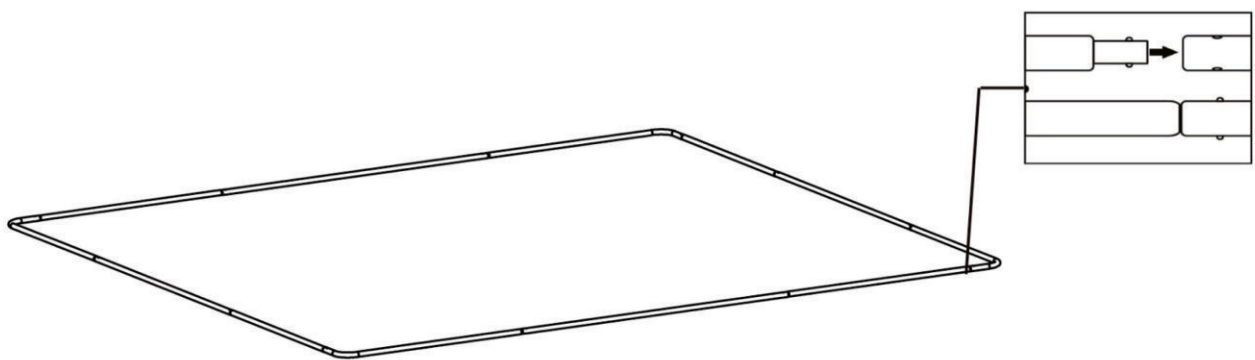

Répétez cette étape deux fois pour le cadre supérieur et inférieur.

x2

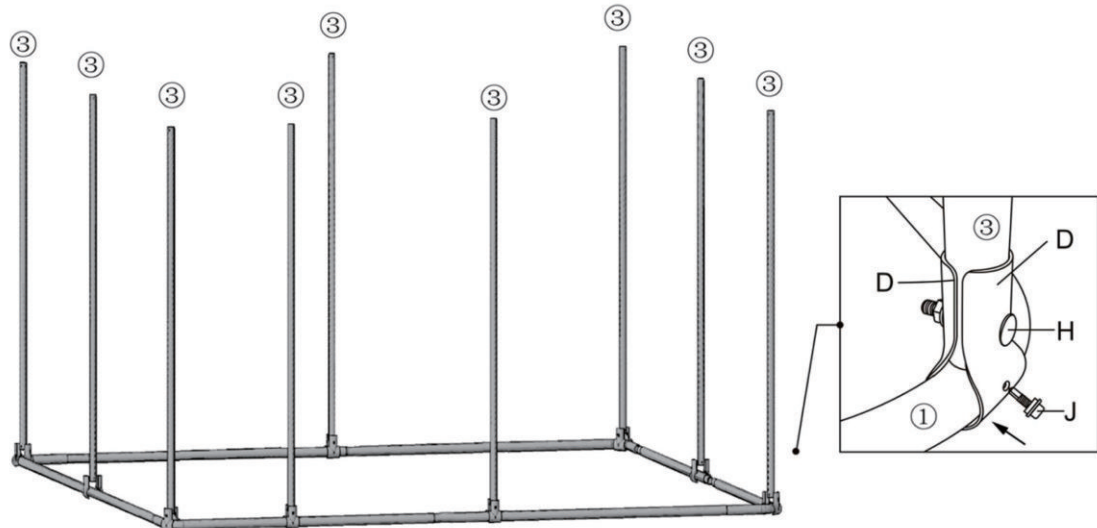

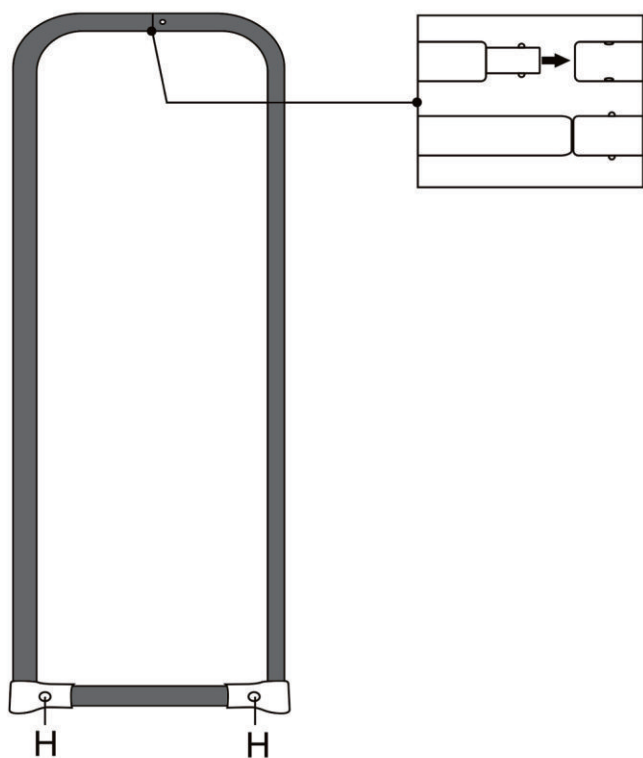
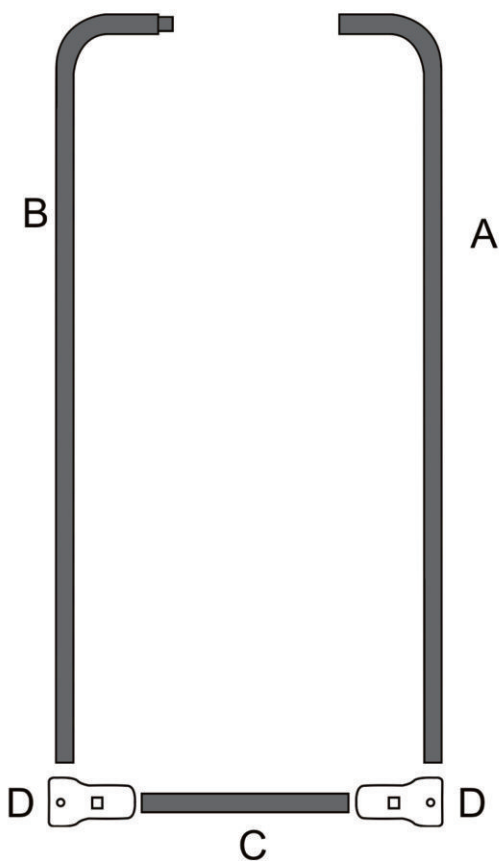
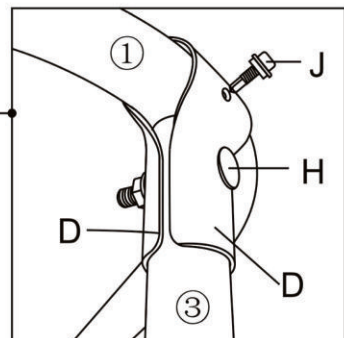
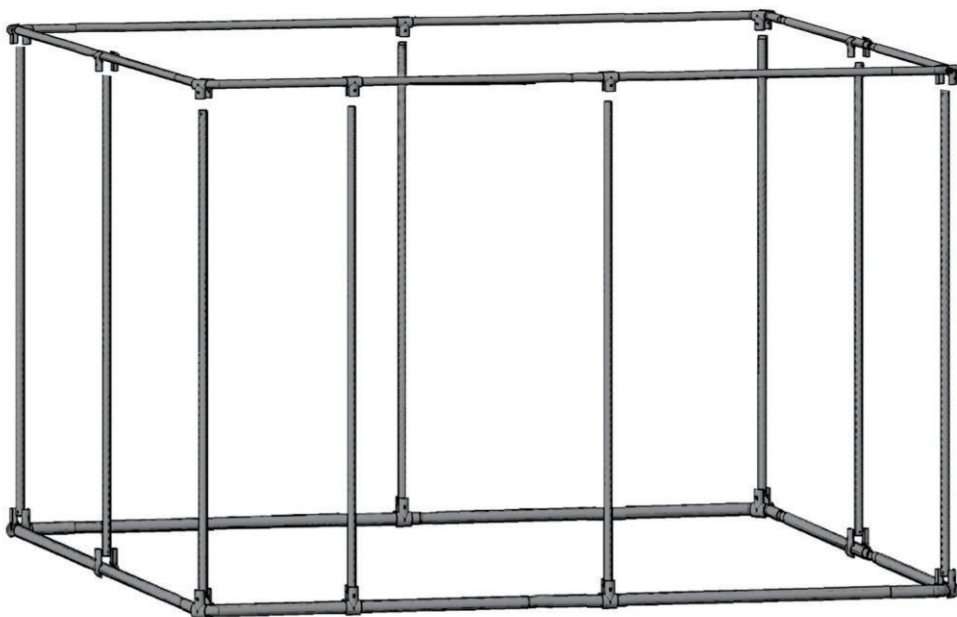

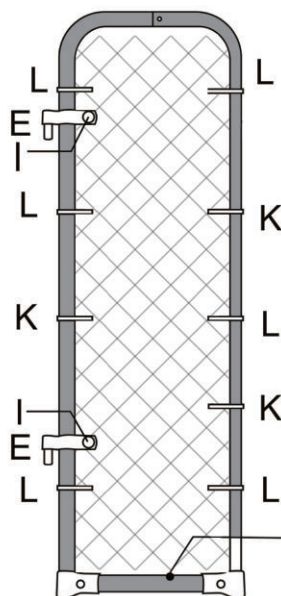

Installez le grillage à mailles losangées sur le cadre du portail. Insérez ensuite les deux tiges rondes dans les bords du grillage, puis utilisez 4 paires de crochets pour fixer les tiges rondes et le tube. Enfin, utilisez le fil de fer pour fixer le grillage à mailles losangées au cadre de la barrière afin de rendre la barrière rigide et résistante.

(Remarque : desserrez les clips sur le poteau pour permettre un ajustement et une fixation exacte).

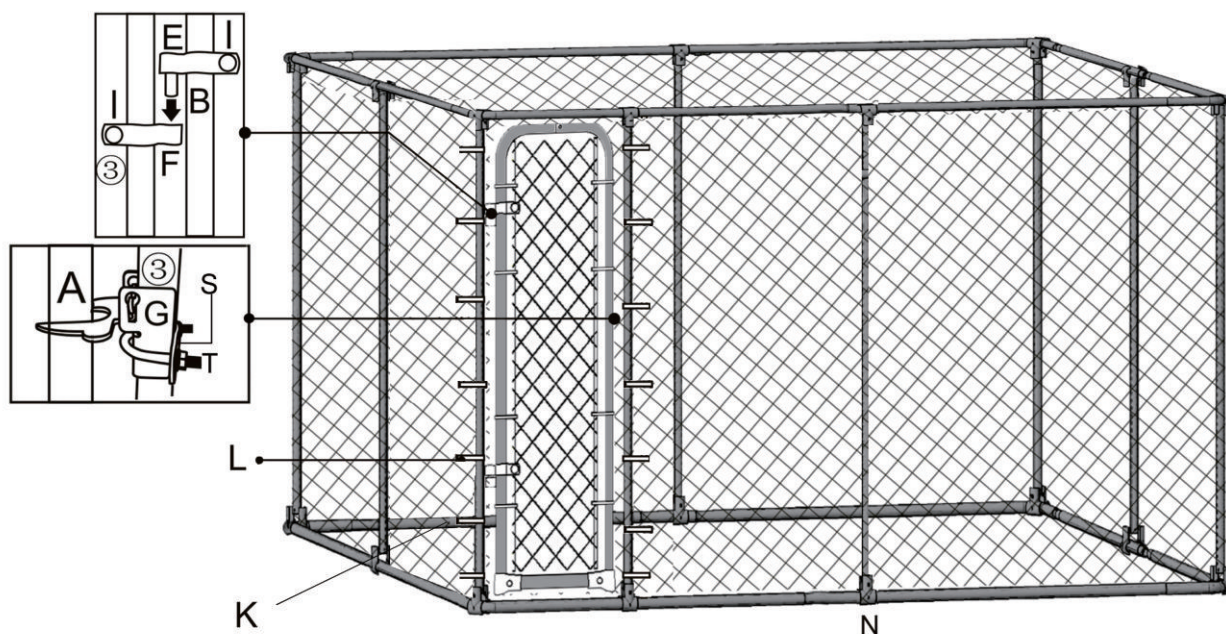

Utilisez les charnières de la porte (et le grand kit de vis) pour fixer la porte au cadre. Installez ensuite la serrure de sécurité sur le parcours pour chiens. Attachez du fil de fer pour fixer le haut et le bas de la porte avec du grillage à mailles losangées et rendez la porte sûre et solide en utilisant la visseuse avec la perceuse pour mettre une vis autotaraudeuse dans les trous pilotes dans les tubes - cela rend également le parcours pour chiens plus solide.

Installation du grillage à mailles losangées

Commencez par dérouler le rouleau de grillage à mailles losangées compressé sur le sol et étendez-le. Puis enrroulez-le à nouveau. Insérez un morceau de tige ronde dans le bord du rouleau de grillage à mailles losangées, puis accrochez la tige ronde au poteau de la porte - une autre personne est alors nécessaire pour dérouler le grillage à mailles losangées autour du cadre de l'enclos pour chiens.

Si le grillage est trop long, retirez une partie du fil à la longueur souhaitée (au moins 15-20 cm de la porte). Insérez un autre morceau de tige ronde dans le bord du grillage pour serrer le grillage et obtenir un bon ajustement. Fixez la tige ronde crochetée au cadre. Pour fixer le haut et le bas du parcours pour chiens, attachez du fil de fer pour fixer le grillage à mailles losangées au cadre. Enfin, assurez-vous que les clips sont bien fixés au cadre à l'aide des vis autotaraudeuses. Votre grand parcours pour chiens est maintenant terminé et prêt à accueillir votre chien.

Avis

1. Il faut au moins 2 personnes pour assembler la cage afin d'éviter d'endommager le tube d'acier.
2. N'utilisez pas cette cage si tous les boulons, vis et écrous ne sont pas fermement fixés.
3. Veuillez l'utiliser sur un sol plat et dur.
4. Ne pas monter et ne pas modifier le produit.
5. Attention, risque de pincement des mains



Avertissement:

A : Assurez-vous que chaque poteau est bien droit.

B : Fixez J avec R et outil électrique dans la bonne direction.

C : Assurez-vous que chaque J est correctement assemblé avant de mettre votre chenil en service.

