

# PawHut

INdlb019V02\_GL

**D51-255**

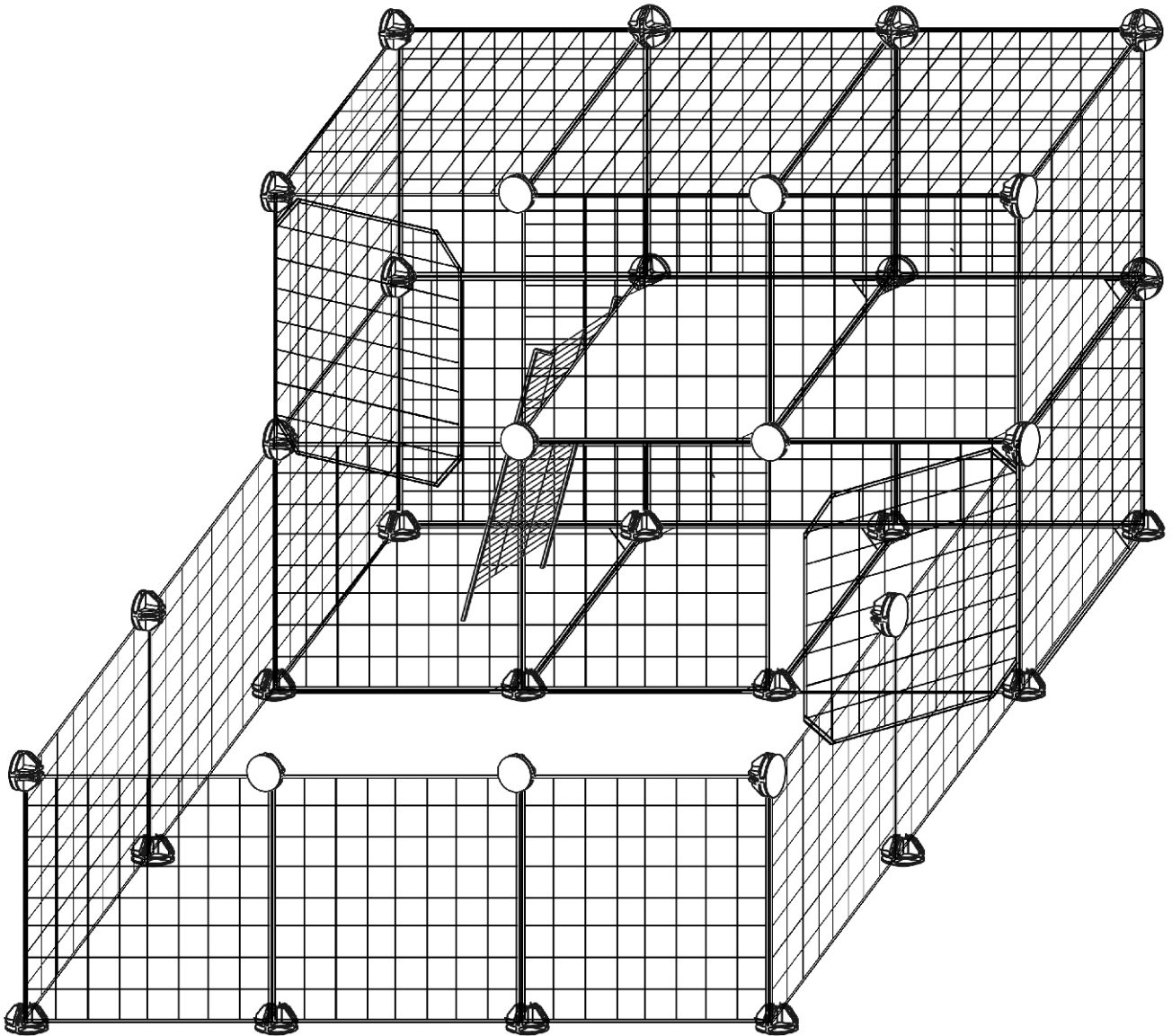

IMPORTANT, RETAIN FOR FUTURE REFERENCE: READ CAREFULLY

## ASSEMBLY & INSTRUCTION MANUAL

**A** x24

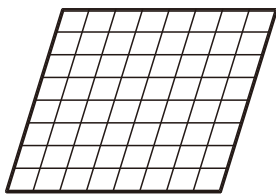

**B** x2

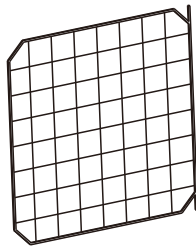

**C** x5

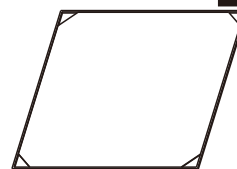

**D** x1

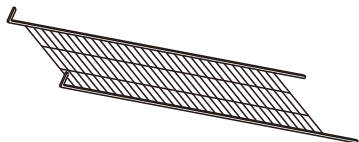

**E** x4



**F** x36



**G** x1

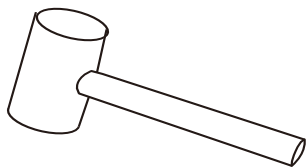

**H** x1

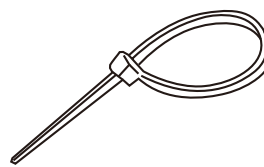

C x 3  
F x 8

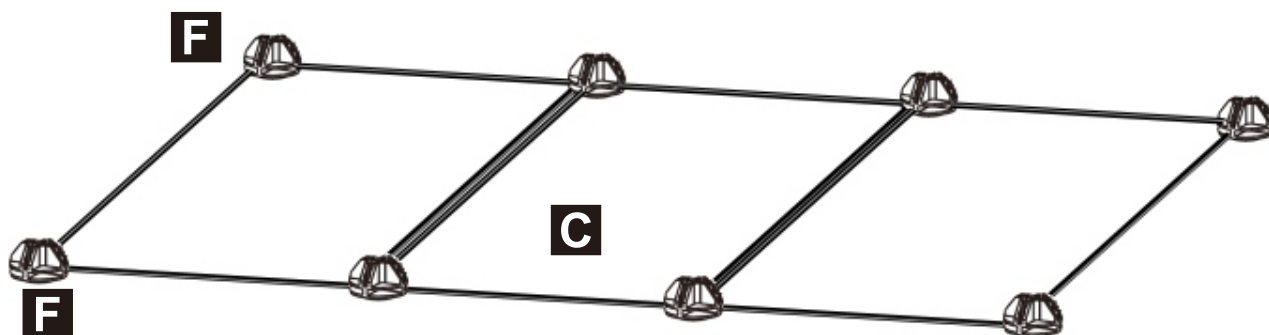

A x 7  
F x 8

02

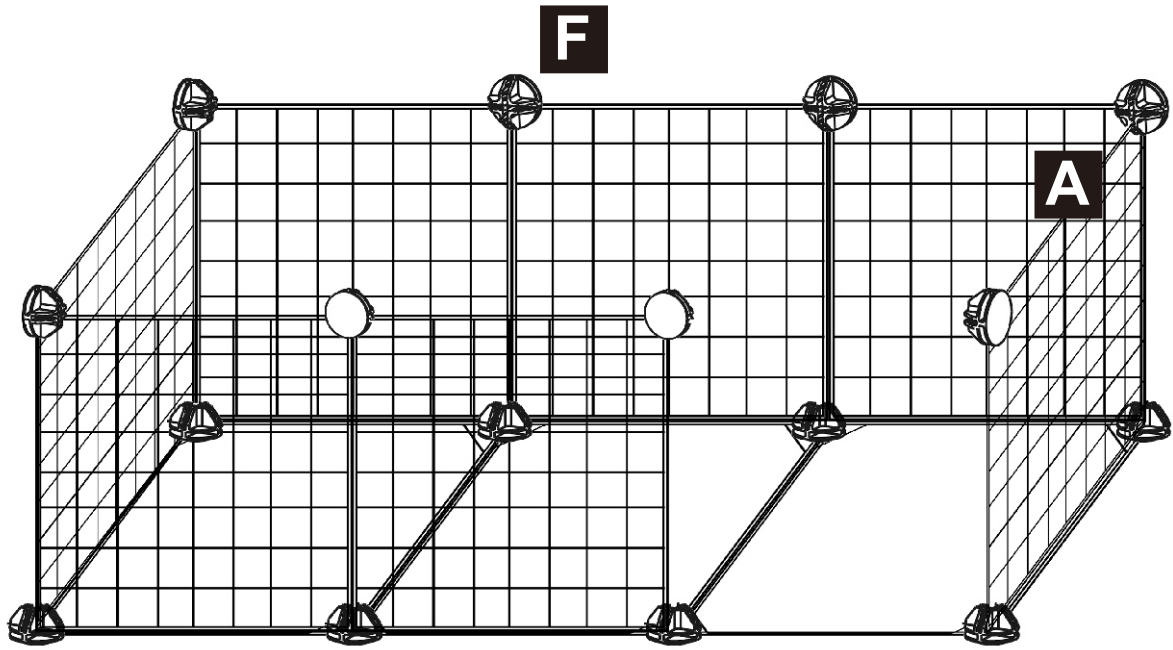

B x 1  
C x 2

03

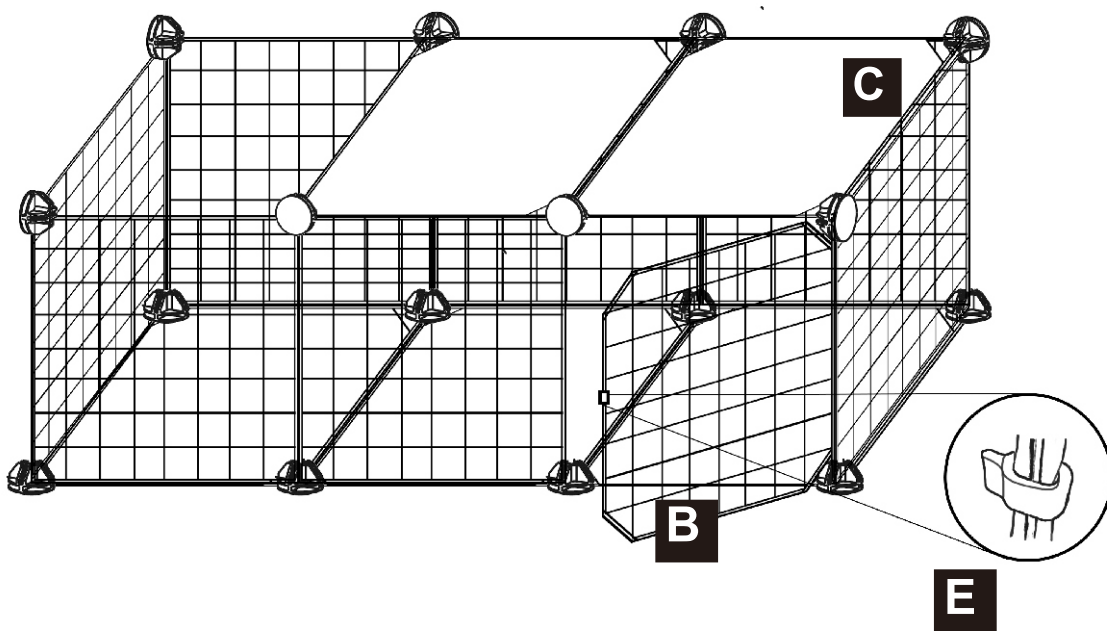

- A x 10
- B x 1
- D x 1
- E x 2
- F x 8

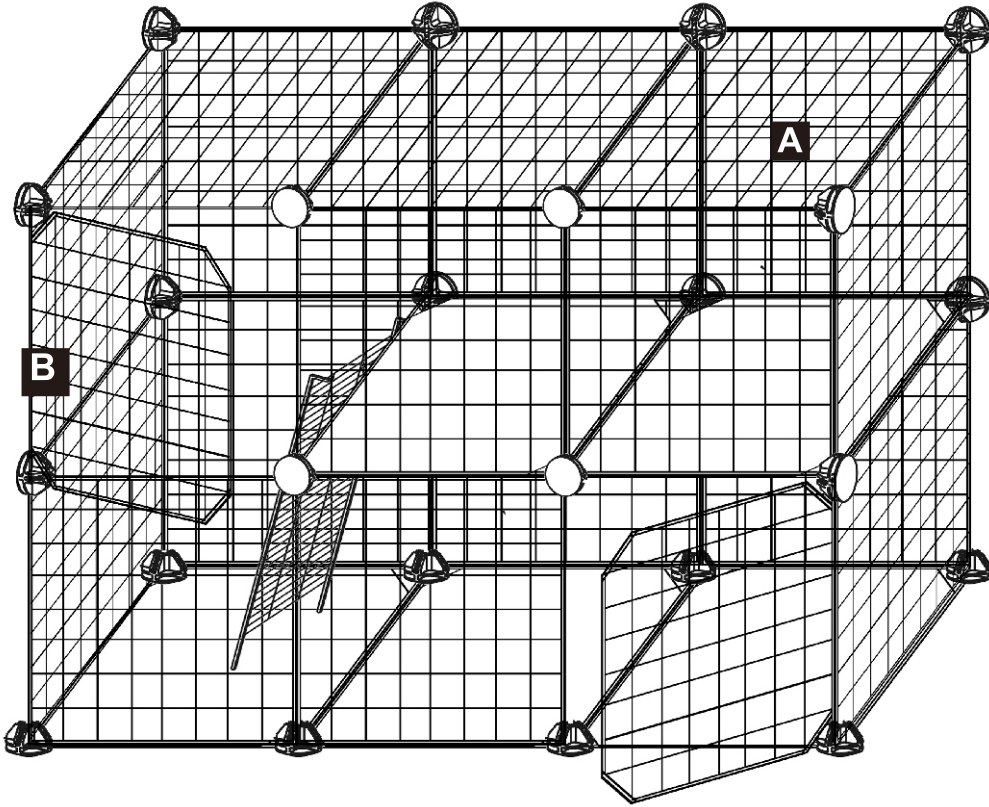

- A x 7
- F x 12

