

PawHut

INdld017_GL

D51-285

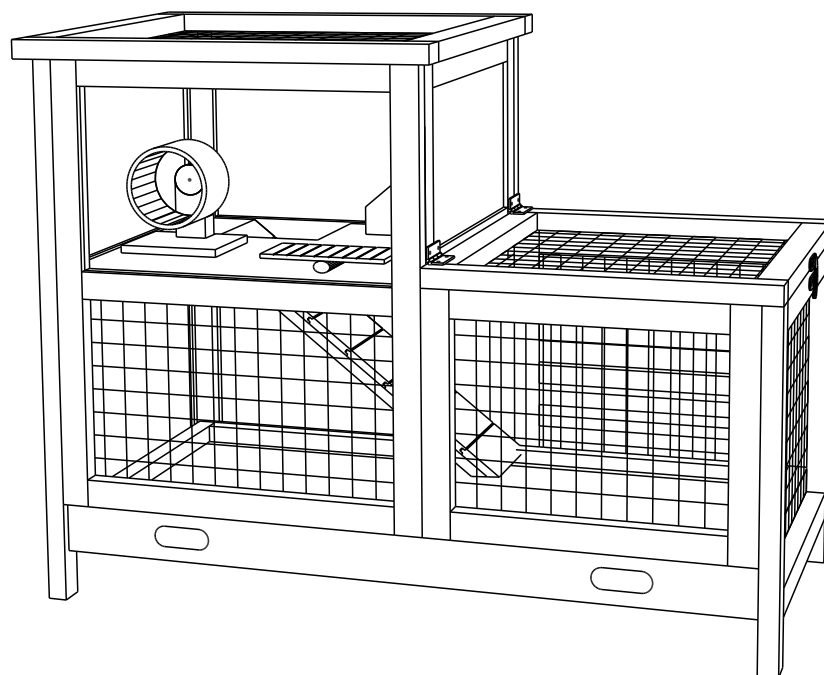

IMPORTANT, RETAIN FOR FUTURE REFERENCE: READ CAREFULLY

ASSEMBLY & INSTRUCTION MANUAL

EN

- 1.This product must be assembled by an adult.
- 2.Do not over torque screws and bolts.
- 3.Do not install in flammable place in case of fire.
- 4.Use on a flat ground.

FR

- 1.Ce produit doit être assemblé par un adulte.
2. Ne serrez pas trop les vis et boulons.
3. N'installez pas le produit à l'endroit inflammable en cas d'incendie.
- 4.Veuillez l'utiliser sur un terrain plat.

ES



- 1.Esta jaula para mascota debe ser ensamblado por un adulto.
- 2.No apriete los tornillos y pernos demasiado.
- 3.Para evitar incendios, no instale la jaula para mascota en un lugar inflamable.
- 4.Utilice la jaula para mascota sobre un terreno plano.

DE

- 1.Dieses Produkt sollte von einem Erwachsenen zusammengestellt werden.
- 2.Ziehen Sie die Schrauben und Bolzen nicht zu fest an.
- 3.Installieren Sie im Brandfall nicht an brennbaren Orten.
- 4.Bitte verwenden Sie es auf einem ebenen Boden.

IT

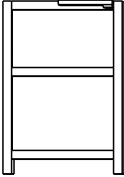
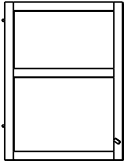
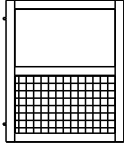
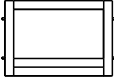
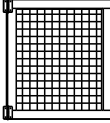
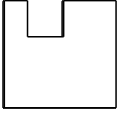
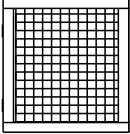
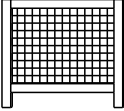
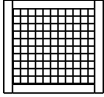
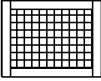
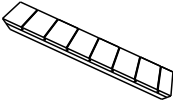
- 1.Questo prodotto va assemblato da un adulto.
- 2.Non stringere eccessivamente viti e bulloni.
- 3.Non installare in un luogo esposto a potenziali incendi.
- 4.Si prega di usare su una superficie piana.

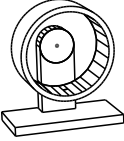
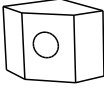
 <p>① x 01</p>	 <p>② x 01</p>	 <p>③ x 01</p>
 <p>④ x 01</p>	 <p>⑤ x 01</p>	 <p>⑥ x 01</p>
 <p>⑦ x 01</p>	 <p>⑧ x 01</p>	 <p>⑨ x 01</p>
 <p>⑩ x 01</p>	 <p>⑪ x 01</p>	 <p>⑫ x 01</p>
 <p>⑬ x 01</p>	 <p>⑭ x 01</p>	 <p>⑮ x 01</p>

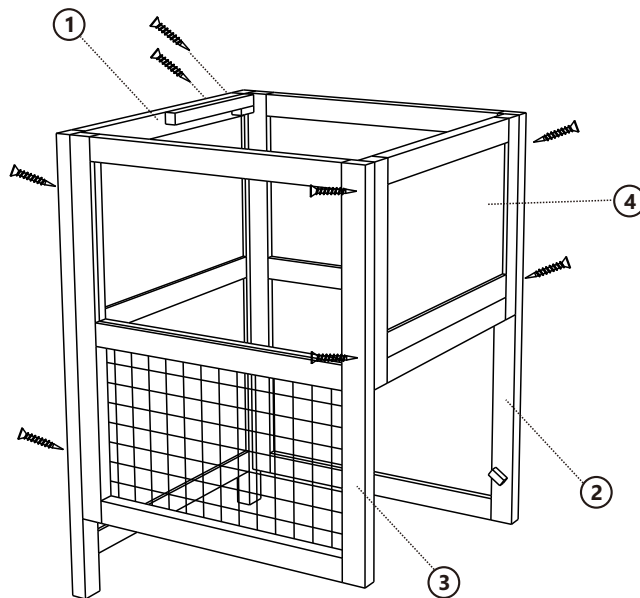
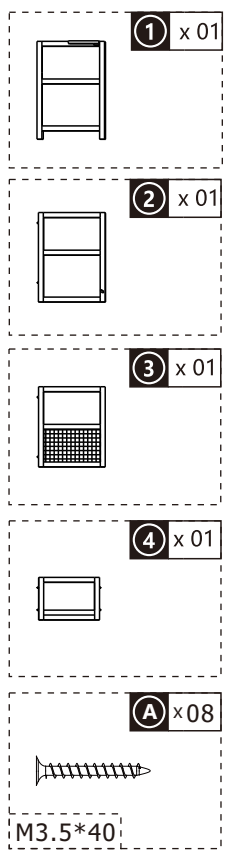
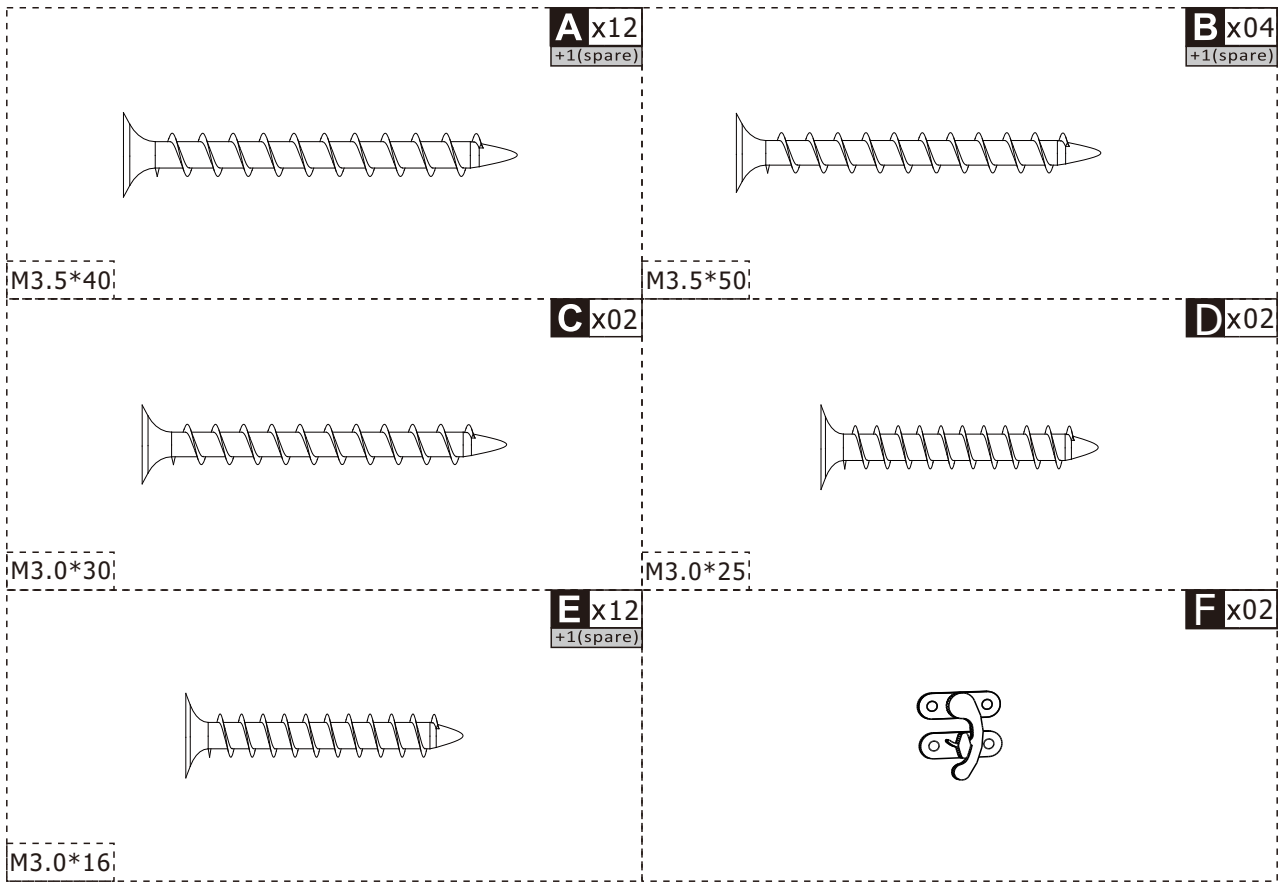

A x 8

8 x01

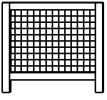

9 x01



10 x01



A x04

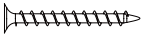

M3.5*40

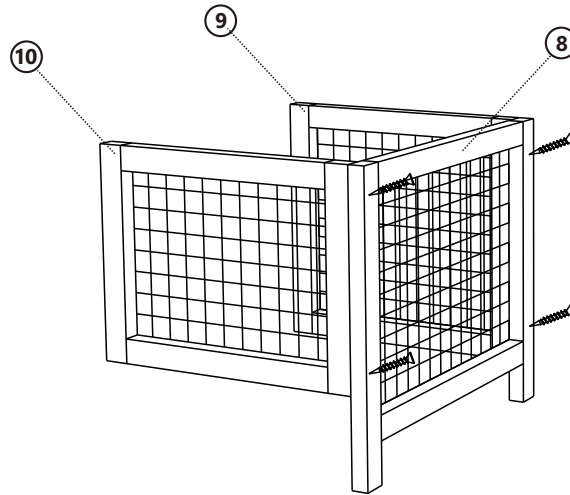

Ax4

B x04

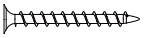

M3.5*50

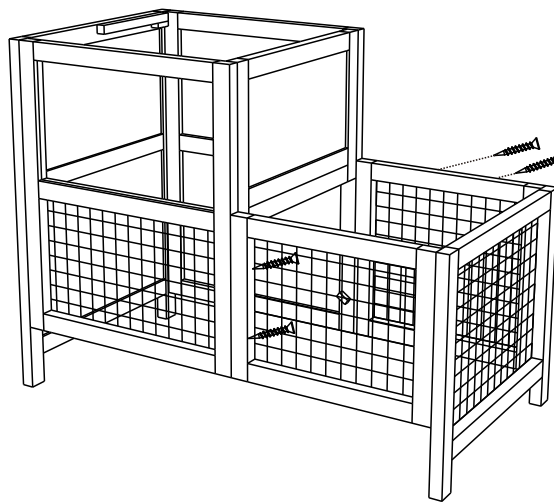

Bx4

6 x 01



11 x 01

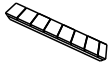

C x 02

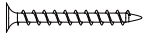

M3.0*30

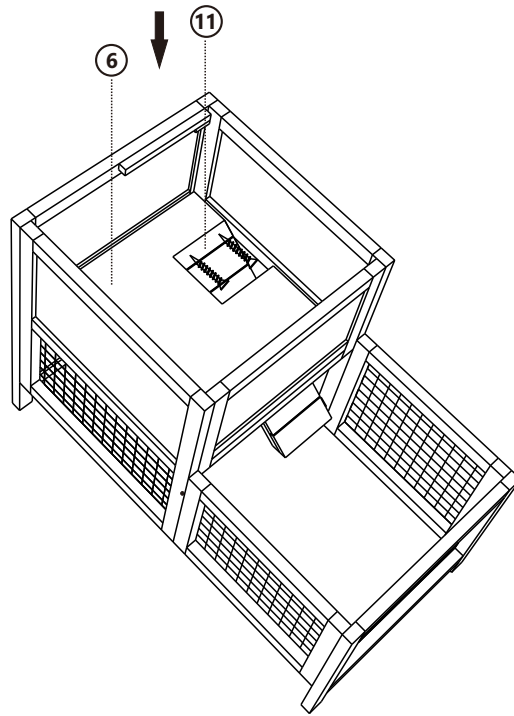

Cx2

12 x 01



13 x 01



14 x 01



15 x 01



D x 02

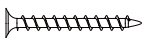

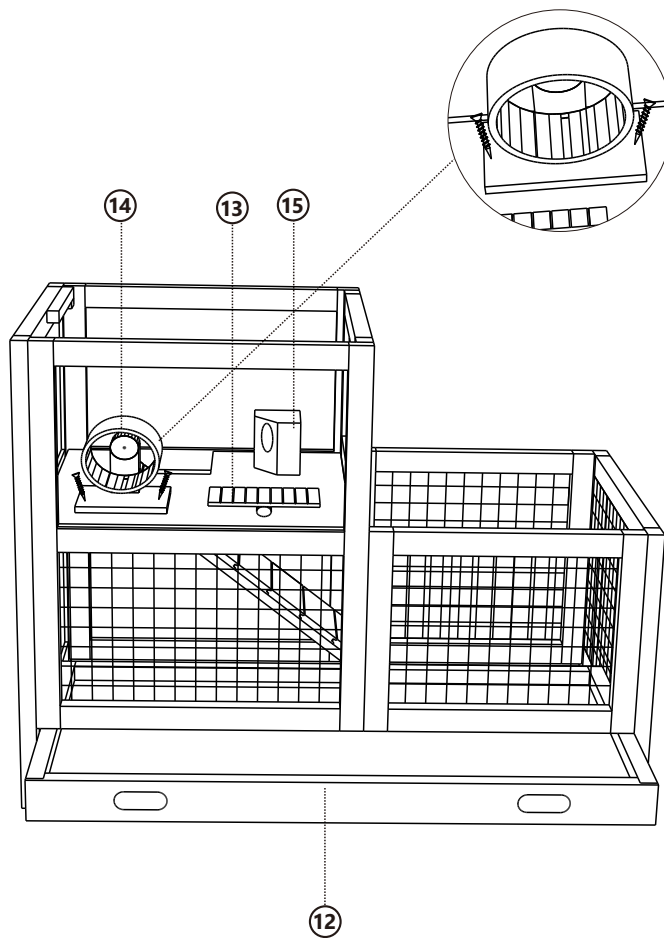

M3.0*25

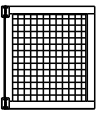
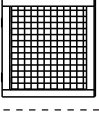

Dx2

Ex12

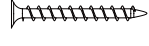
-  5 x 01
-  7 x 01
-  F x 02
-  E x 12
M3.0*16

