



INedb038V02\_UK\_FR\_ES\_DE\_IT

**84B-372**



READ AND SAVE THIS INSTRUCTIONS FOR FUTURE USE

**ASSEMBLY & INSTRUCTION MANUAL**

# Garden Chairs

## **IMPORTANT-KEEP THIS INFORMATION FOR YOUR SUBSEQUENT CONSULTATION: READ CAREFULLY**

**Only for domestic use**

### **Use tips:**

- \*Put the chair stably on a flat floor.
- \*Mount the garden chairs in the shelter of the weather.
- \*Stay away from open flames.
- \*Don't hang anything in the structure.
- \*Avoid the overload at the anchors/structure.
- \*It is advised that don't stay on the chairs when there is a storm.
- \*It is recommended to protect in case of strong wind or rain and in your absence.

### **Precautions before assembly:**

- \*Prepare a clean and dry mounting area.
- \*Verify that the product is not damaged.
- \*Check that none of the pieces are missing.

### **Maintenance:**

- \*Clean with a soft fabric.
- \*Regularly remove leaves and / or water collected on the canvas.
- \*Check the chair regularly.

### **Storage conditions:**

\*The fabric should be stored completely dry, in a clean and dry place to avoid the risks of mold.

### **Caution with the risks of pinching or cuts during assembly.**

**The manufacturer declines all responsibility in case of damages due to a bad installation or due to weather.**

# Chaises de jardin

**IMPORTANT - CONSERVEZ CES INFORMATIONS POUR VOTRE CONSULTATION ULTÉRIEURE: LISEZ ATTENTIVEMENT**

**Seulement pour usage domestique**

**Conseils:**

- \* Placez la chaise de manière stable sur un sol plat.
- \* Installez les chaises de jardin à l'abri des intempéries.
- \* Restez à l'écart des flammes ouvertes.
- \* Ne rien accrocher dans la structure.
- \* Évitez de surcharger les extrémités de la structure
- \* Il est conseillé de ne pas rester sur la chaise en cas d'orage.
- \* Il est recommandé de la protéger en cas de vent fort ou de pluie et en votre absence.

**Précautions avant l'assemblage:**

- \* Préparez une zone de montage propre et sèche.
- \* Vérifiez que le produit n'est pas endommagé.
- \* Vérifiez qu'aucun des morceaux ne manque.

**Entretien:**

- \* Nettoyer avec un tissu doux.
- \* Enlevez régulièrement les feuilles et / ou l'eau recueillie sur la toile.
- \* Vérifiez la chaise fréquemment.

**Conditions de stockage:**

- \* Le tissu doit être stocké complètement à sec, dans un endroit propre et sec pour éviter les risques de moisissure.

**Attention aux risques de pincement ou de coupure lors du montage.**

**Le fabricant décline toute responsabilité en cas de dommage dû à une mauvaise installation ou aux intempéries.**

# Sillas para Jardín

## **IMPORTANTE-CONSERVE ESTA INFORMACIÓN PARA SU CONSULTA POSTERIOR: LEER DETALLA DAMENTE**

**Solamente para uso doméstico**

### **Consejos de uso:**

- \*Coloque el balancín de forma estable sobre un suelo plano.
- \*Monte las sillas de jardín en el toldo.
- \*Manténgase alejado de llamas abiertas.
- \*No cuelgue nada en la estructura.
- \*Envite la sobrecarga en los anclajes.
- \*Se aconseja no permanecer en el balancín cuando hay tormenta.
- \*Se recomienda resguardar en caso de viento o lluvia fuerte y en su ausencia.

### **Precauciones antes del montaje:**

- \*Prepare una zona de montaje limpia y seca.
- \*Verificar que el producto no este dañado.
- \*Controlar que no falta ninguna de las piezas.

### **Mantenimiento:**

- \*Limpiar con la ayuda de un paño suave.
- \*Eliminar regularmente las hojas y/o agua recogidas sobre la lona.
- \*Inspeccione las sillas regularmente.

### **Condiciones de almacenaje:**

- \*La tela debe ser guardada totalmente seca, en un lugar limpio y seco para evitar los riesgos de moho.

**Precaución con los riesgos de pinzamientos o cortes durante el montaje.**

**El fabricante declina toda responsabilidad en caso de deterioros debidos a una mala instalación o por causas meteorológicas.**



# Gartenstühle

## **WICHTIG – BITTE HEBEN SIE DIESE ANLEITUNG FÜR EINE SPÄTERE BEZUGNAHME AUF: SORGFÄLTIG DURCHLESEN**

### **Nur für den häuslichen Gebrauch bestimmt**

#### **Nutzungshinweise:**

- \* Bitte stellen Sie die Schaukel stabil auf eine ebene Fläche.
- \* Stellen Sie die Stühle an einen wettergeschützten Ort.
- \* Von offenen Feuerquellen fernhalten.
- \* Hängen Sie nichts an die Struktur.
- \* Vermeiden Sie eine Überlastung der Anker.
- \* Es wird empfohlen, die Schaukel bei schlechten Wetterbedingungen nicht zu benutzen.
- \* Es wird empfohlen, die Schaukel während Ihrer Abwesenheit vor starkem Regen oder starkem Wind zu schützen.

#### **Vorsichtsmaßnahmen vor der Montage:**

- \* Bitte bereiten Sie einen sauberen und trockenen Montagebereich vor.
- \* Stellen Sie sicher, dass das Produkt nicht beschädigt ist.
- \* Vergewissern Sie sich, dass keines der Zubehöerteile fehlt.

#### **Instandhaltung:**

- \* Bitte reinigen Sie die Schaukel nur mit einem weichen Tuch.
- \* Bitte entfernen Sie regelmäßig alle Blätter und / oder Wasser, die sich auf dem Stoff angesammelt haben.
- \* Überprüfen Sie die Gartenstühle regelmässig.

#### **Lagerung:**

- \* Der Stoff sollte an einem völlig trockenen und sauberen Ort aufbewahrt werden, um Schimmel zu vermeiden.

#### **Vorsicht vor Quetsch- und Schnittgefahr bei der Montage.**

**Der Hersteller lehnt jede Haftung für Schäden ab, die durch unsachgemäße Installation oder Witterungseinflüsse verursacht wurden.**

# Sedie da giardino

**IMPORTANTE-CONSERVARE QUESTE INFORMAZIONI  
PER CONSULTARLE IN SEGUITO: LEGGERE  
ATTENTAMENTE**

**Solo per uso domestico**

**Consigli per l'uso:**

- \*Posizionare l'altalena saldamente su una superficie piana.
- \*Montare le sedie da giardino al riparo dalle intemperie del tempo.
- \*Tenere lontano dal fuoco.
- \*Non appendere alcun oggetto alla struttura.
- \*Evitare di sovraccaricare le giunture.
- \*E' consigliabile di non utilizzare l'altalena quando fuori c'e' un temporale.
- \*E' consigliabile di proteggere l'altalena dalla pioggia o da forti venti in vostra assenza.

**Precauzioni prima del montaggio:**

- \*Preparare un'area di assemblaggio pulita e asciutta.
- \*Verificare che il prodotto non sia danneggiato.
- \*Controllare che nessun pezzo manchi.

**Manutenzione:**

- \*Pulire con un panno morbido.
- \*Rimuovere regolarmente foglie e / o acqua depositata sul telo.
- \*Controllare le sedie regolarmente.







**Condizioni per il deposito:**

\*Il tessuto va riposto completamente asciutto in un luogo asciutto e pulito per evitare i rischi di muffa.

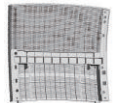
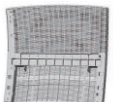
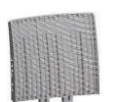
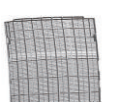
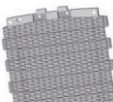





**Cautela causa rischio di tagli o pizzicamenti durante l'assemblaggio.**

**Il produttore declina ogni responsabilita' in caso di lesioni derivanti da montaggio inaccurato o dalle condizioni metereologiche.**





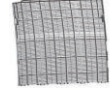
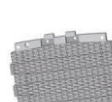

**BOX-1/4**

NO.	PARTS	QTY
R S		1
L S		1
C B		2
C B C		2
C S		2
C F		2
C R		2
M L 1		1
M L		1
D		2





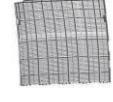
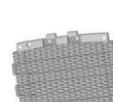

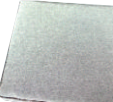

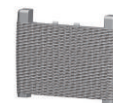
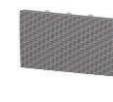

**BOX-2/4**

NO.	PARTS	QTY
R S		1
L S		1
C B		1
C B C		1
C S		1
C F		1
C R		1
D		1

**BOX-3/4**

NO.	PARTS	QTY
R S		1
L S		1
C B		1
C B C		1
C S		1
C F		1
C R		1
D		1

**BOX-4/4**

NO.	PARTS	QTY
N S T		2
L S T		2
F T		1
T		1
B R		3
B L		3
L F		3
R F		3
A		1
B		8
C		58

**RS x 3**

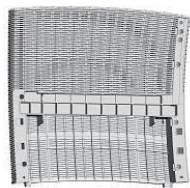

**NST x 2**

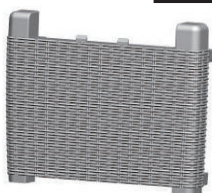

**BL x 3**



**LS x 3**

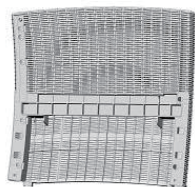

**LST x 2**

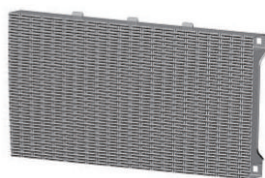

**LF x 3**



**CB x 4**

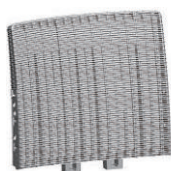

**FT x 1**



**RF x 3**



**CBC x 4**

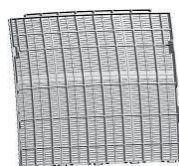

**T x 1**

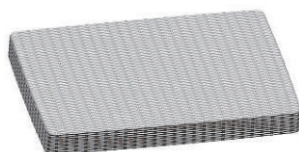

**A x 1**



**CS x 4**

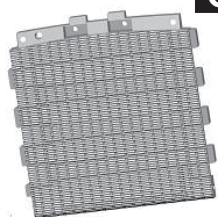

**ML x 1**



**B x 8**



**CF x 4**



**ML1 x 1**



**C x 58**



**CR x 4**

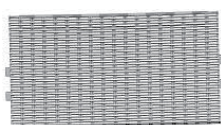

**BR x 3**



**D x 4**

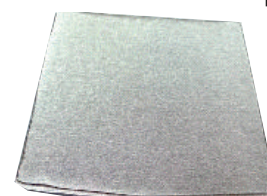



CS x 1

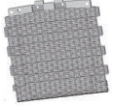

CF x 1



CF

Click

CS

x2

CB x 1



CS



CB

x2

B x 2



C x 2

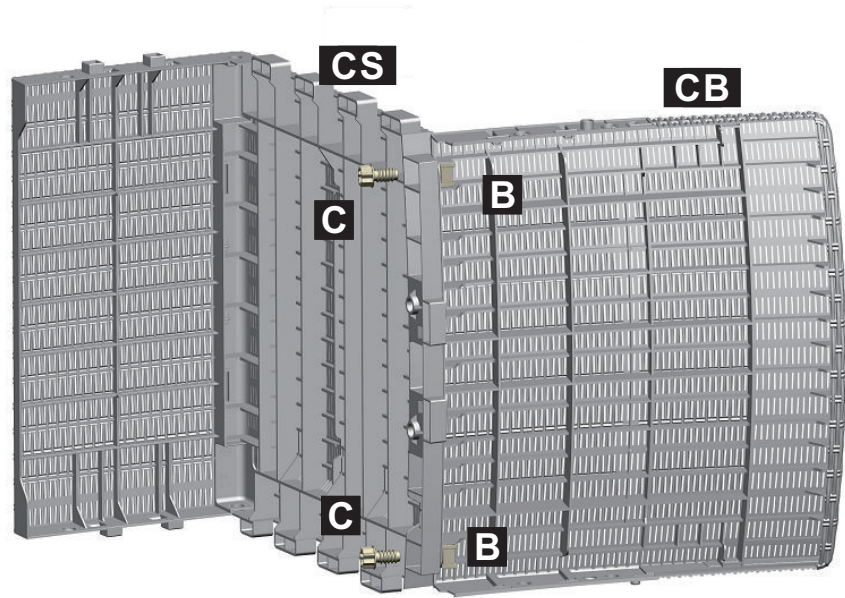
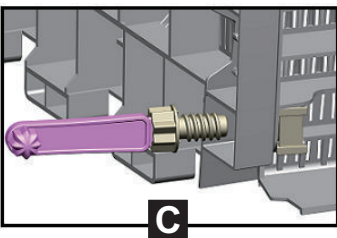
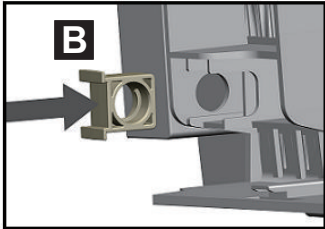

x2

CR x 1

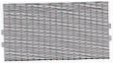

C x 2

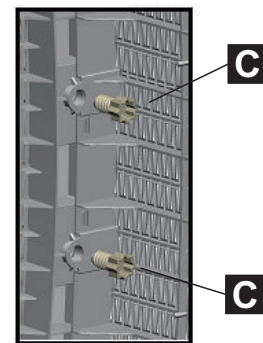
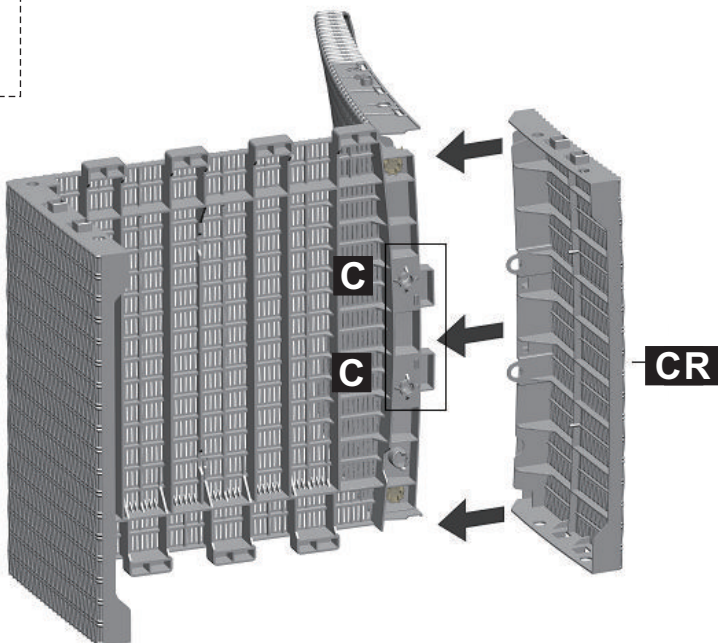

x2



LS x 1

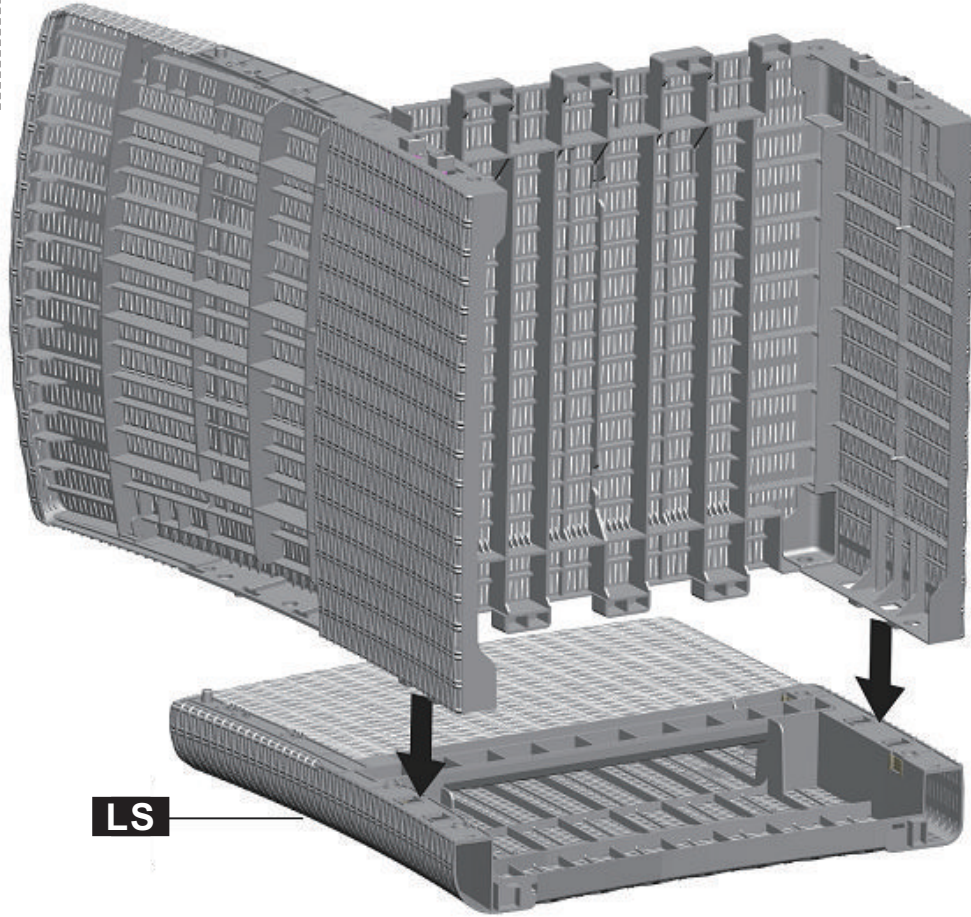

LS

x2

C x 6

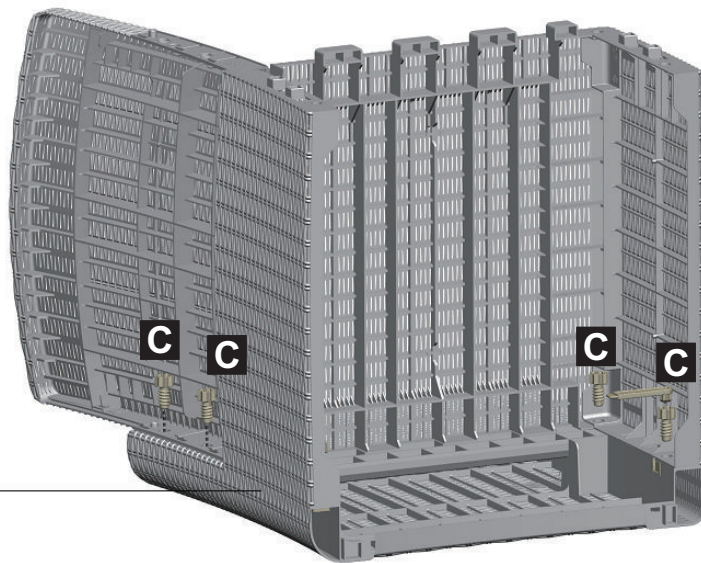
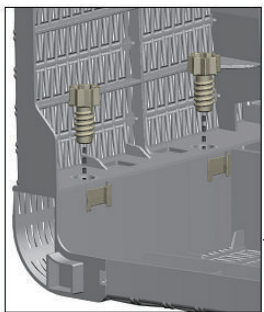
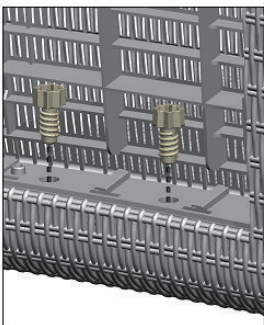

C

C

C

C

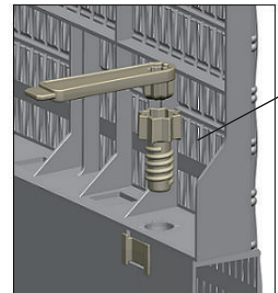

C

x2

RS x 1

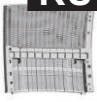

RS



x2

C x 6

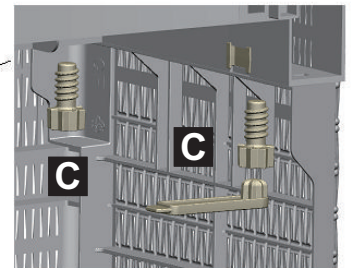
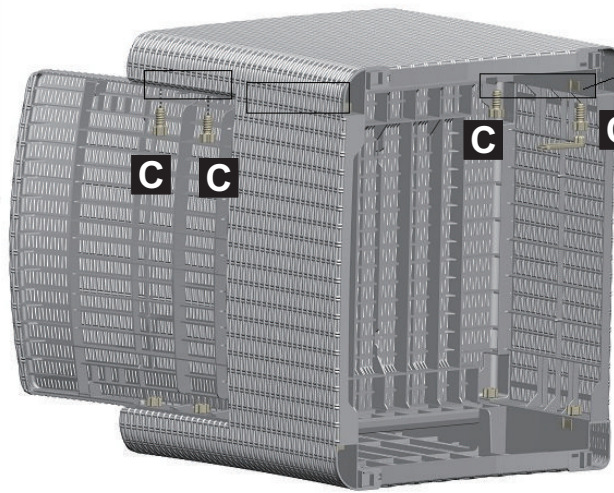
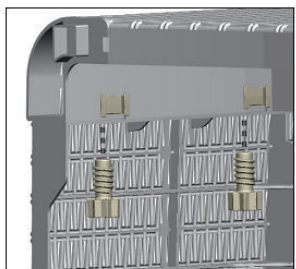
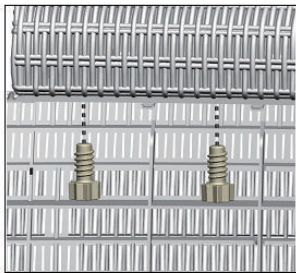

x2



BR x 1



BL x 1



LF x 1



RF x 1

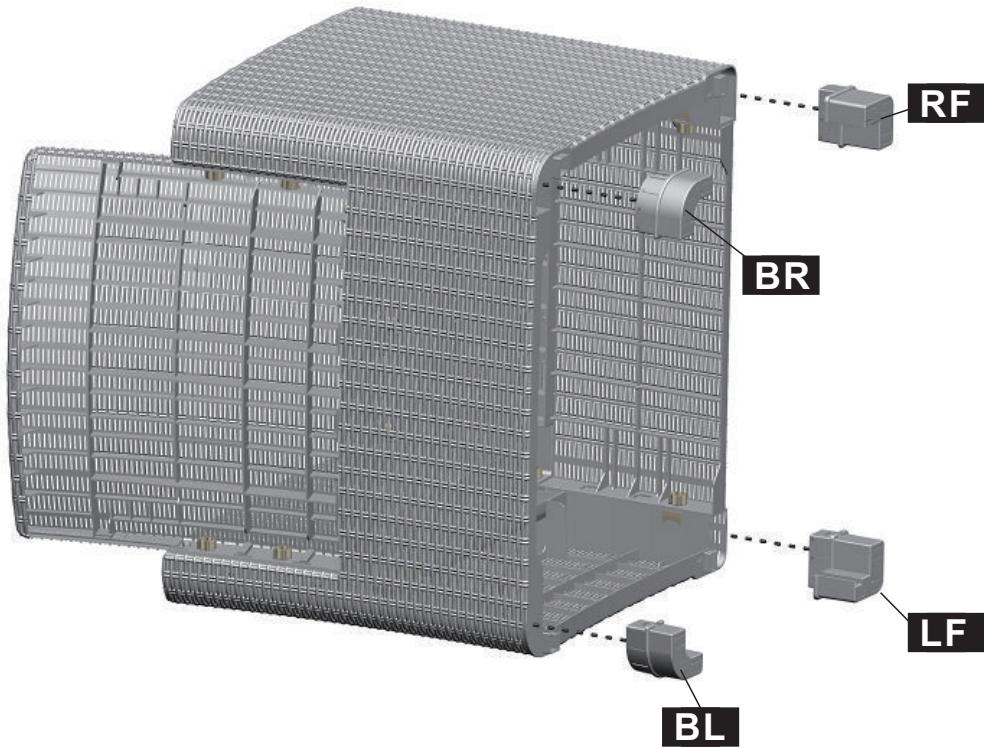

x2

CBC x 1

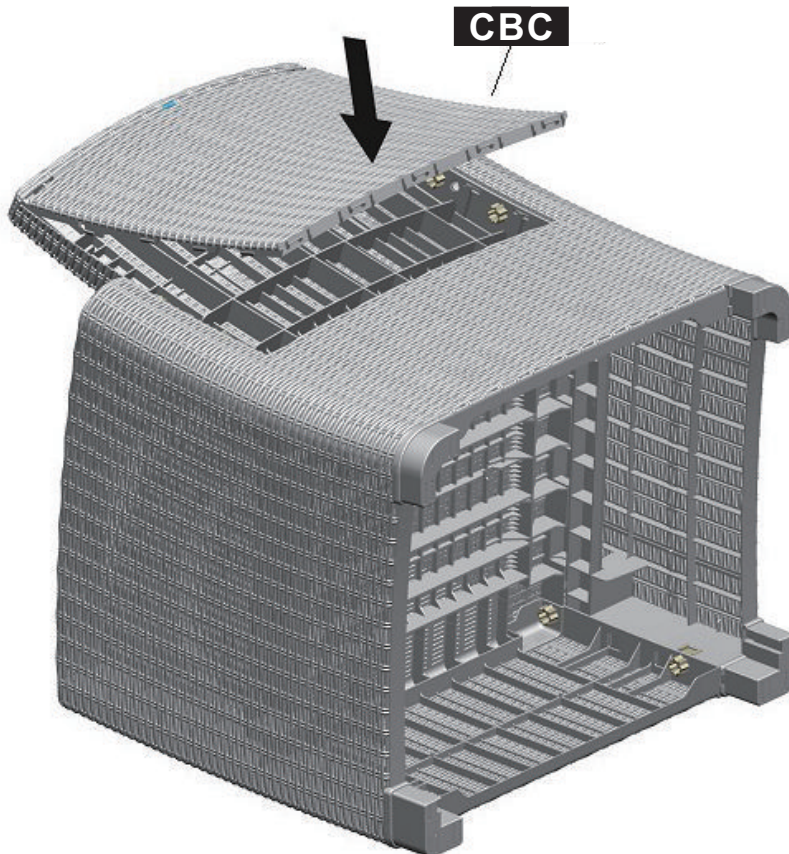

x2



CS x 1

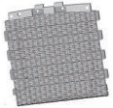

CF x 1



CF

Click

CS

x2

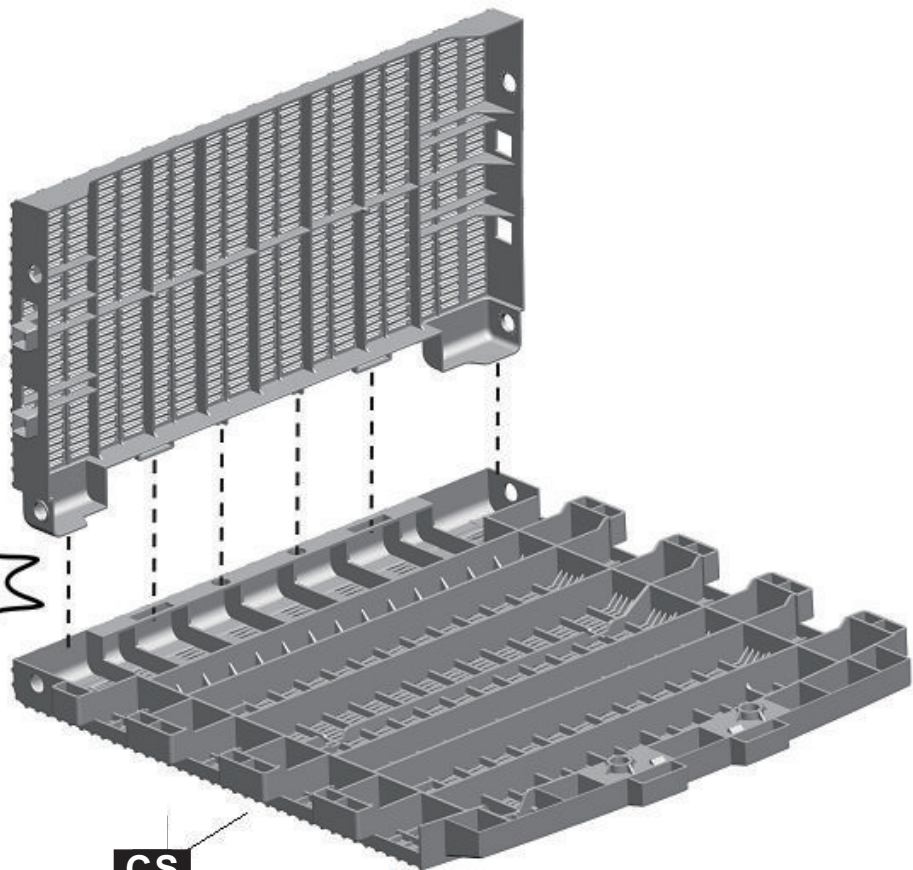



CB x 1



CS



CB

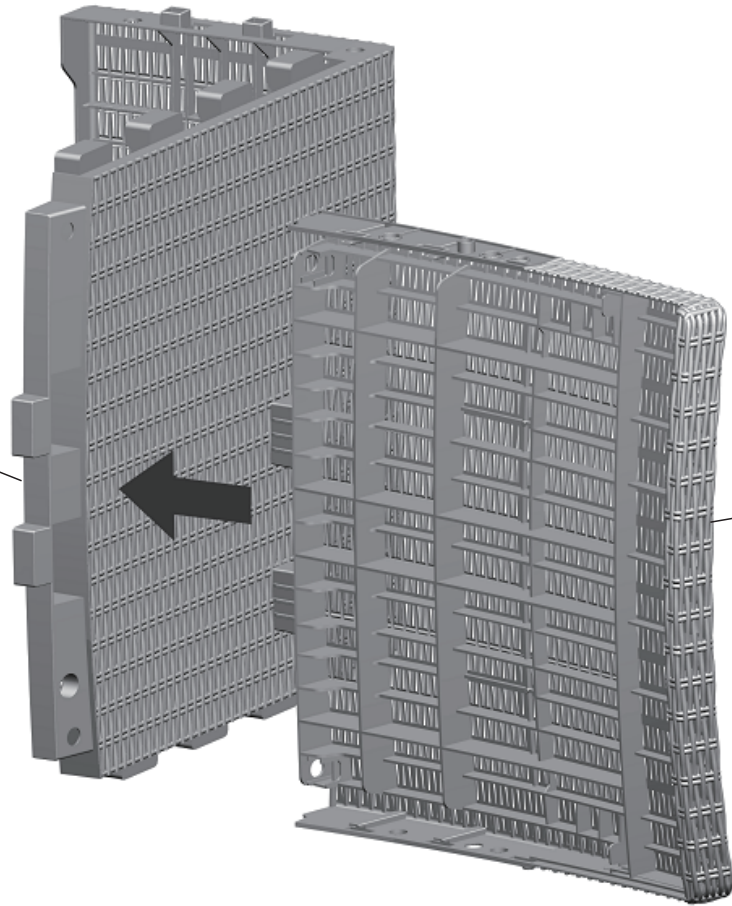

x2

B x 2



C x 2



B

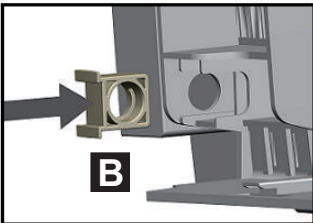

C

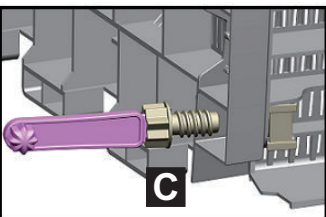

CS

CB

C

B

C

B

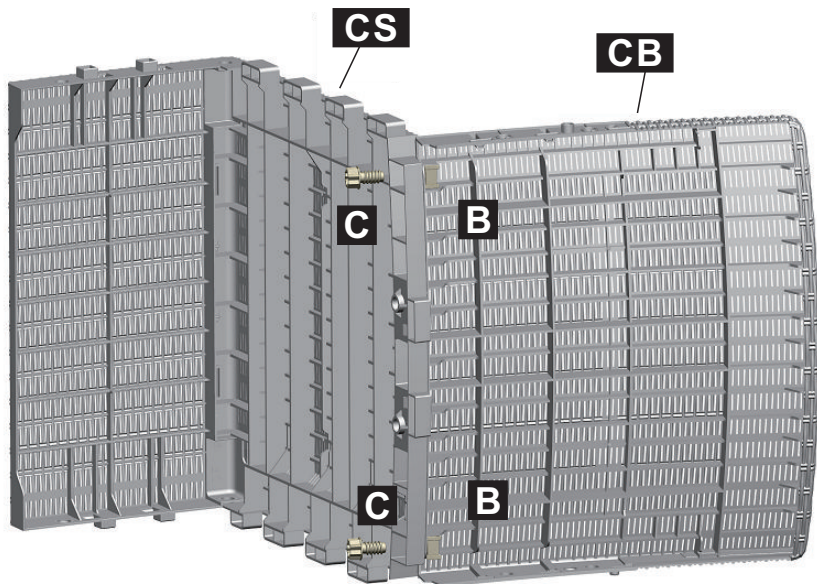

x2

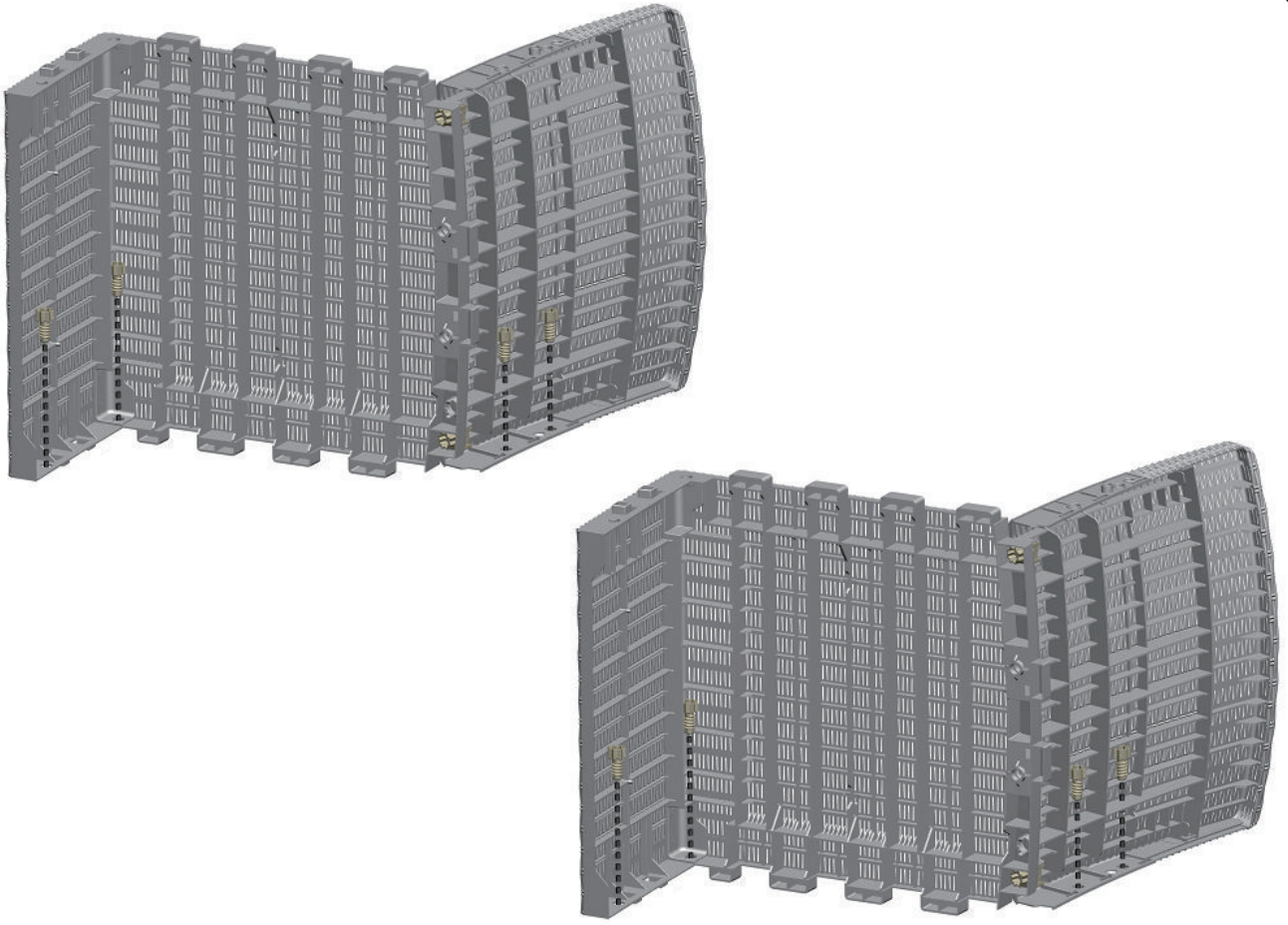

RS x 1



C x 4

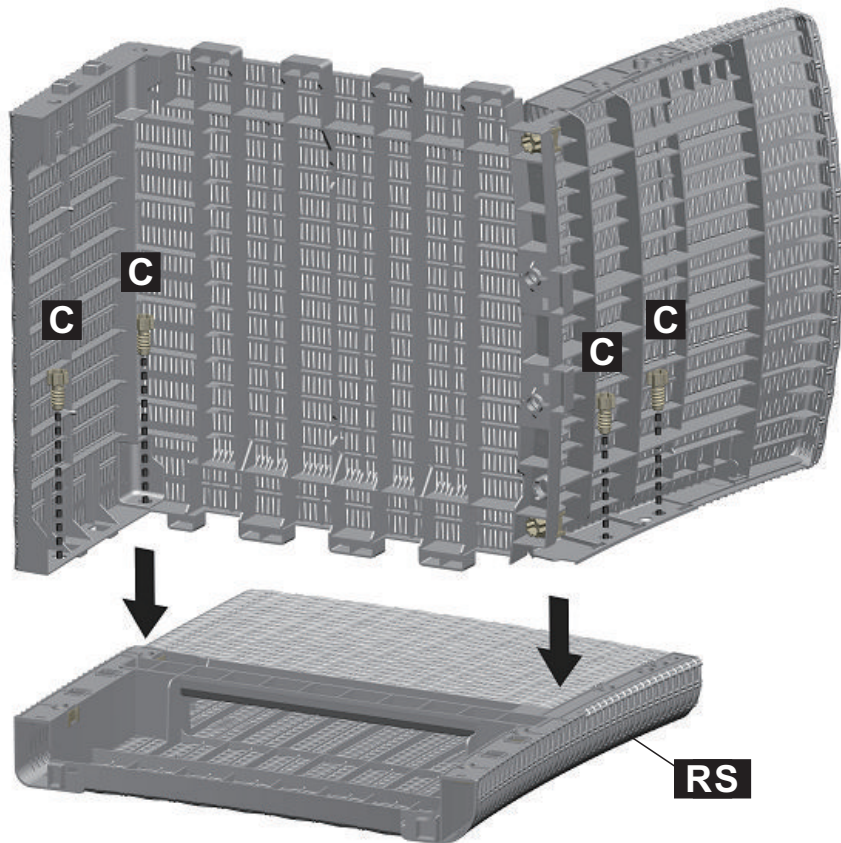



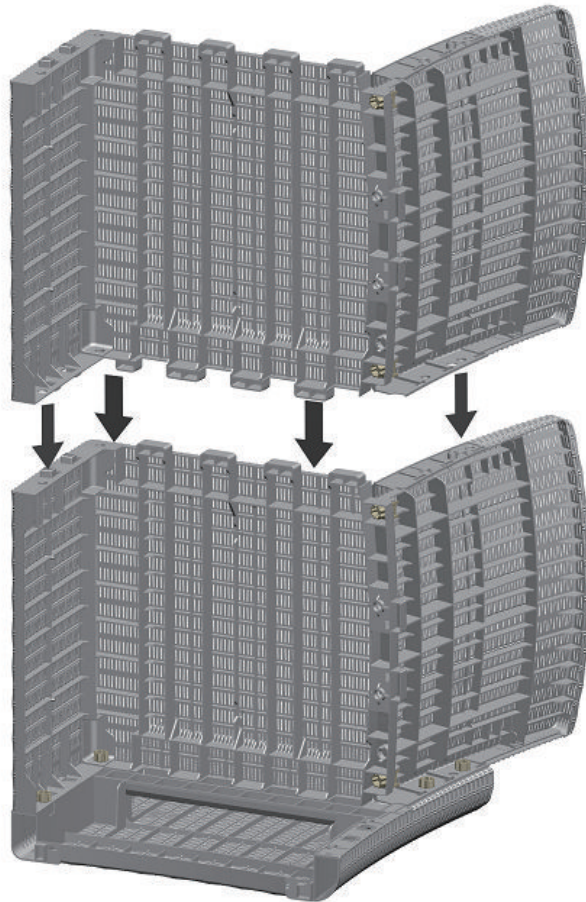

ML x 1

ML1 x 1

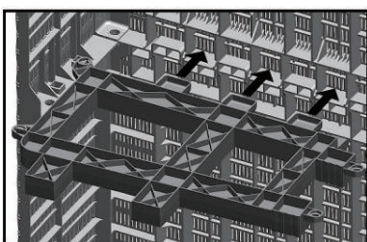
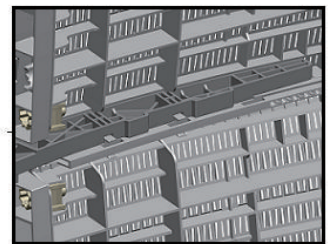
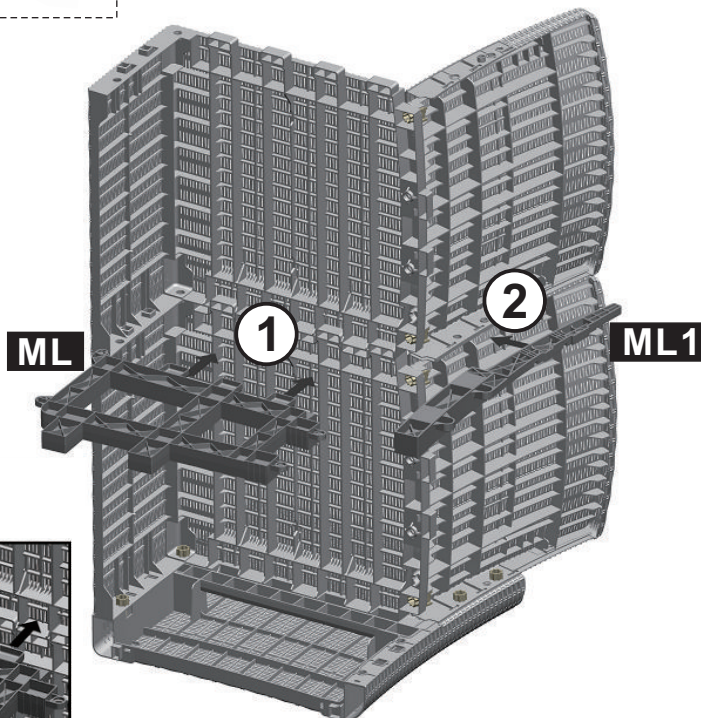
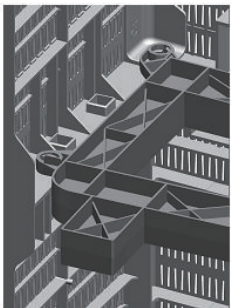

C x 4

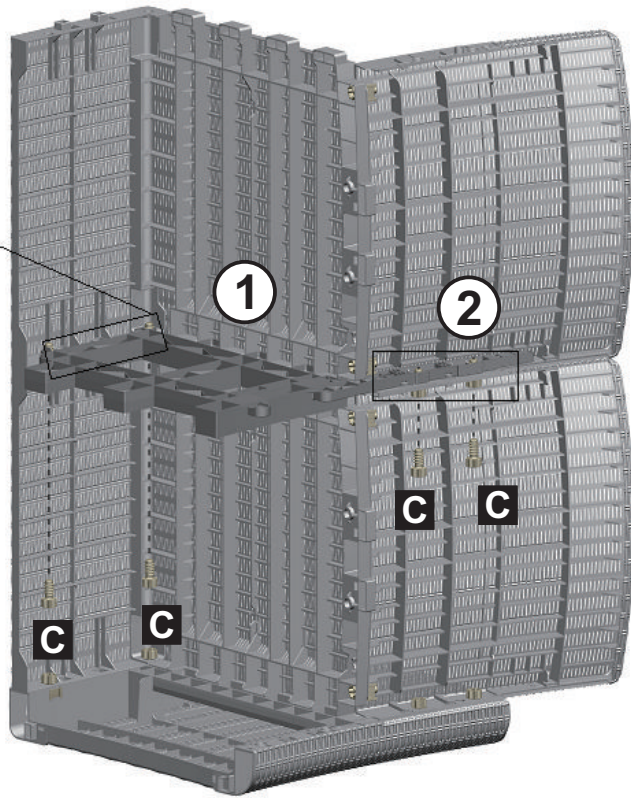
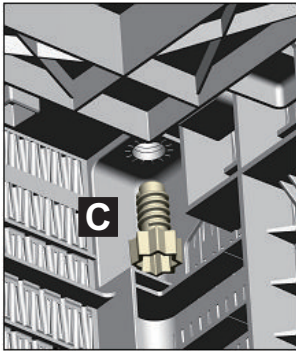

CR x 2

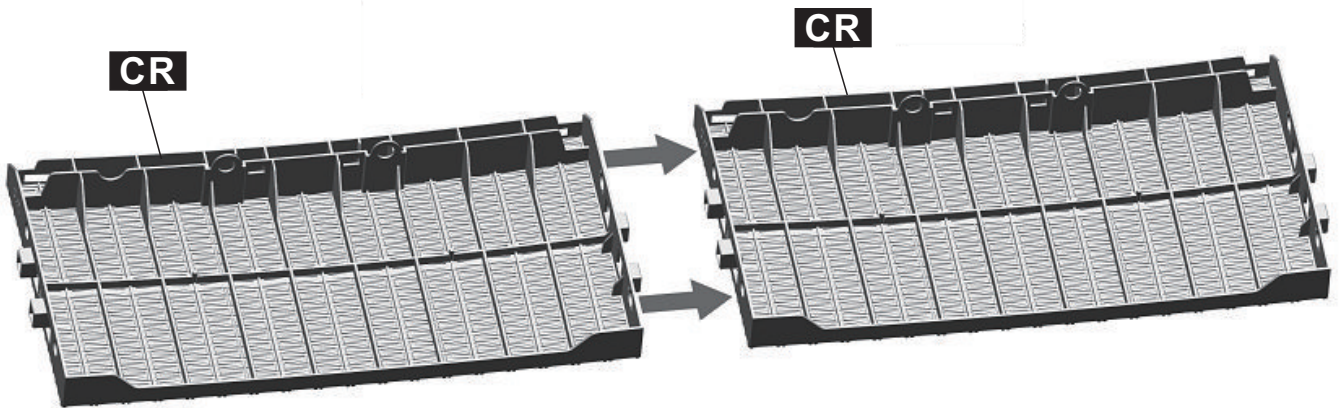
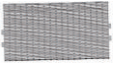



C x 8

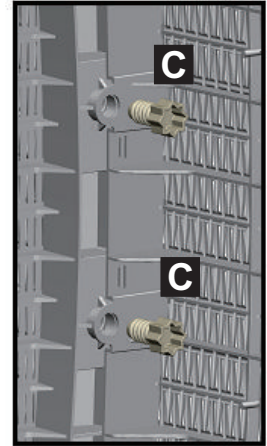
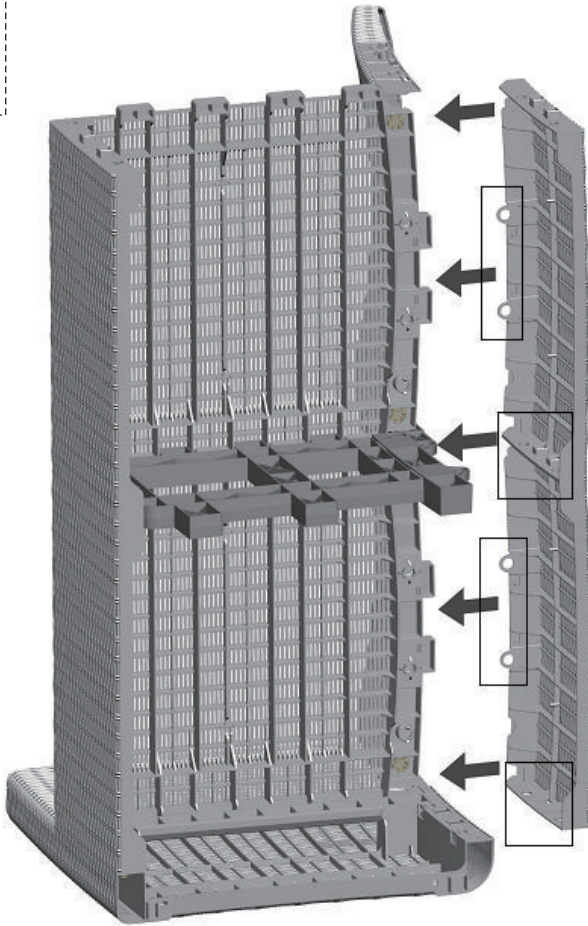

LS x 1

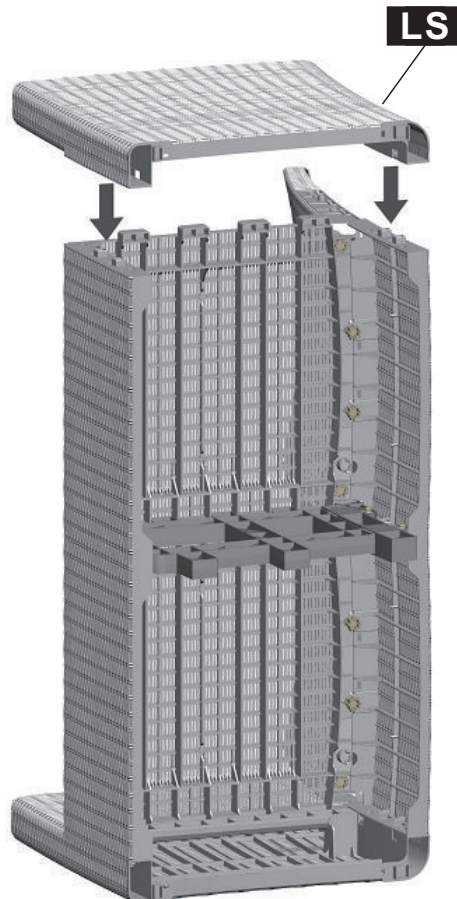

C x 6

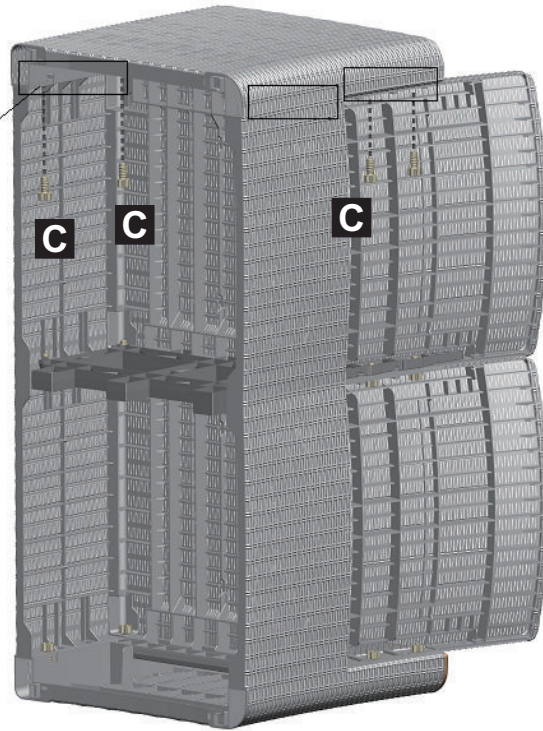
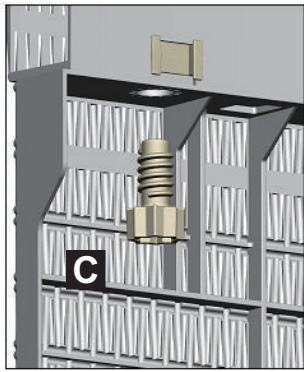

BR x 1



BL x 1



LF x 1



RF x 1

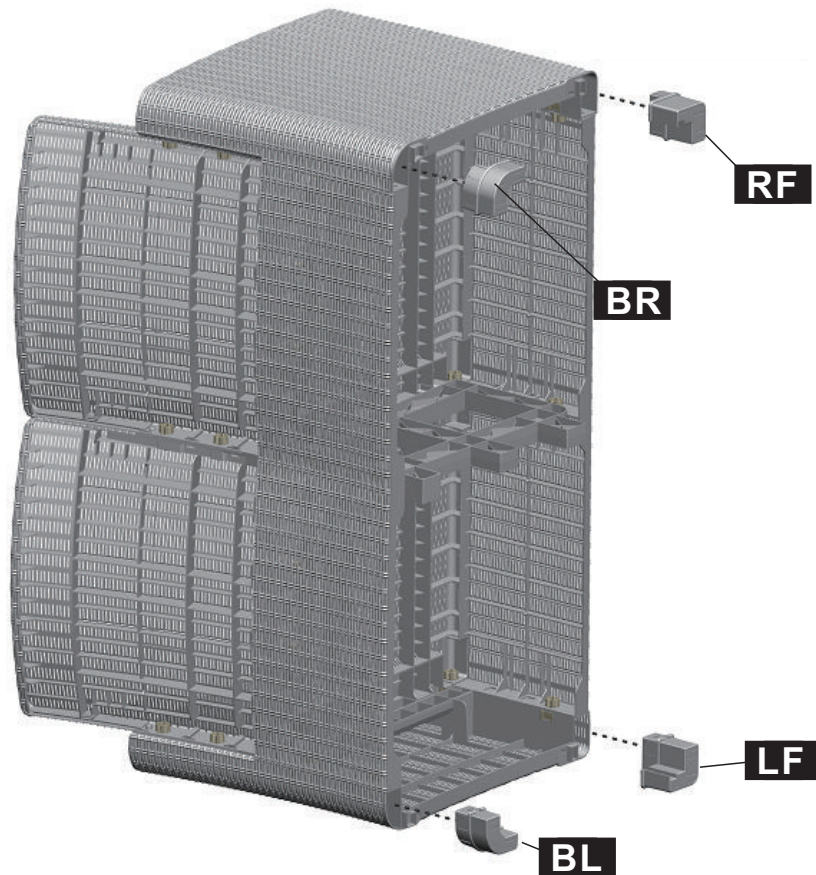



CBC x 2

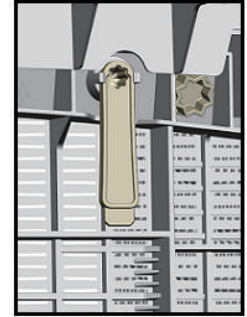
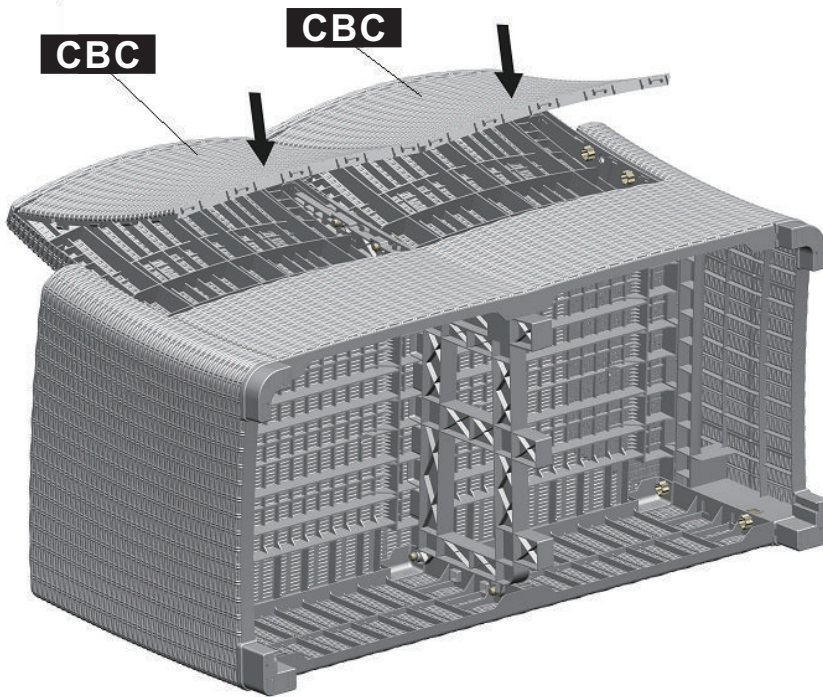

NST x 1

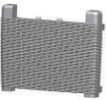

LST x 2

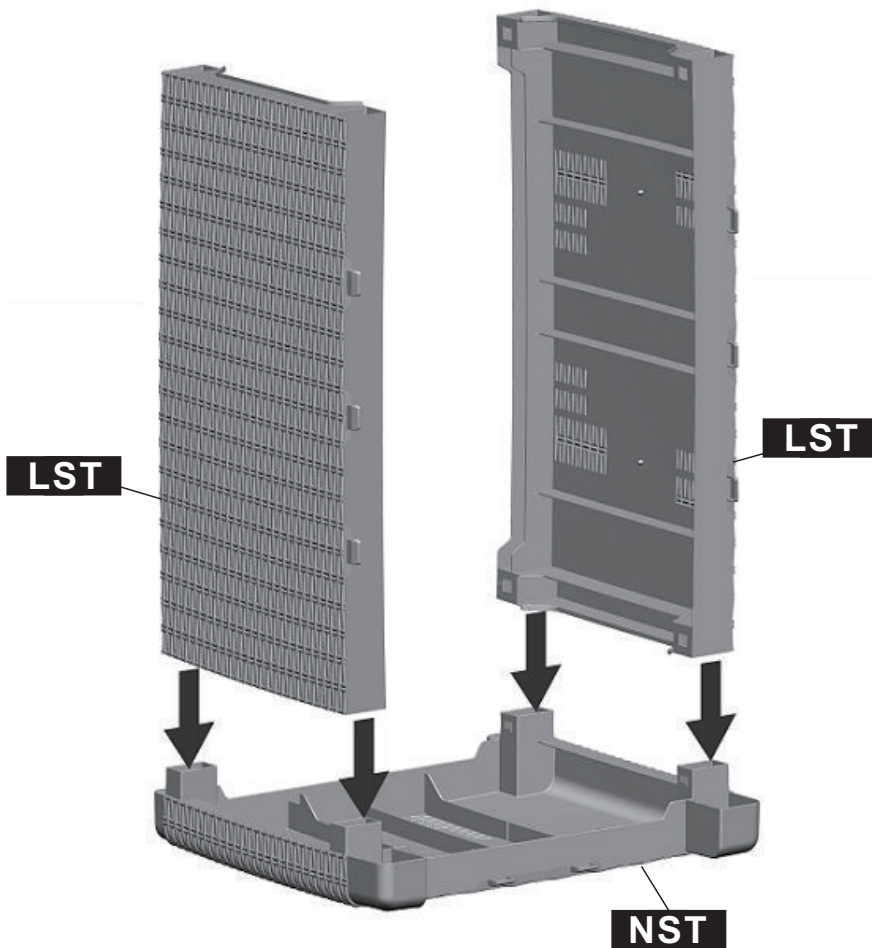
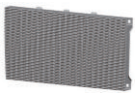

FT x 1

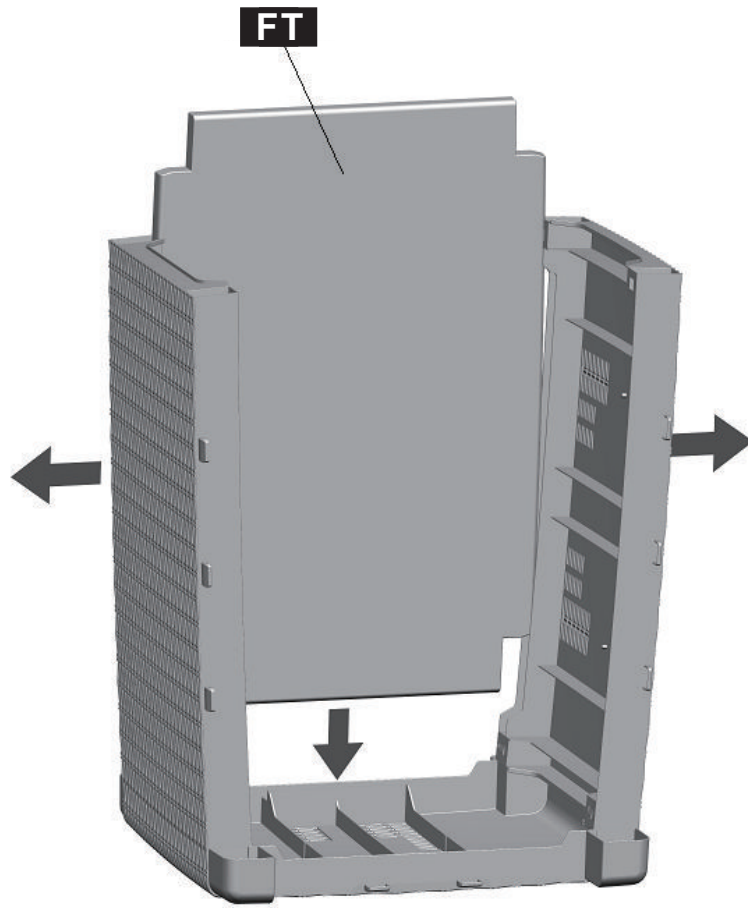
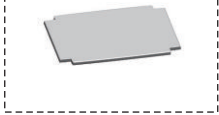

NST x 1

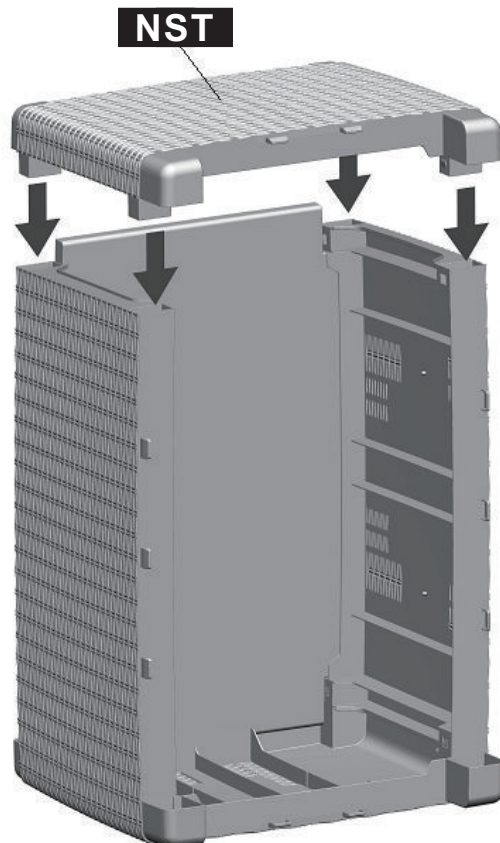
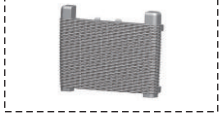

T x 1

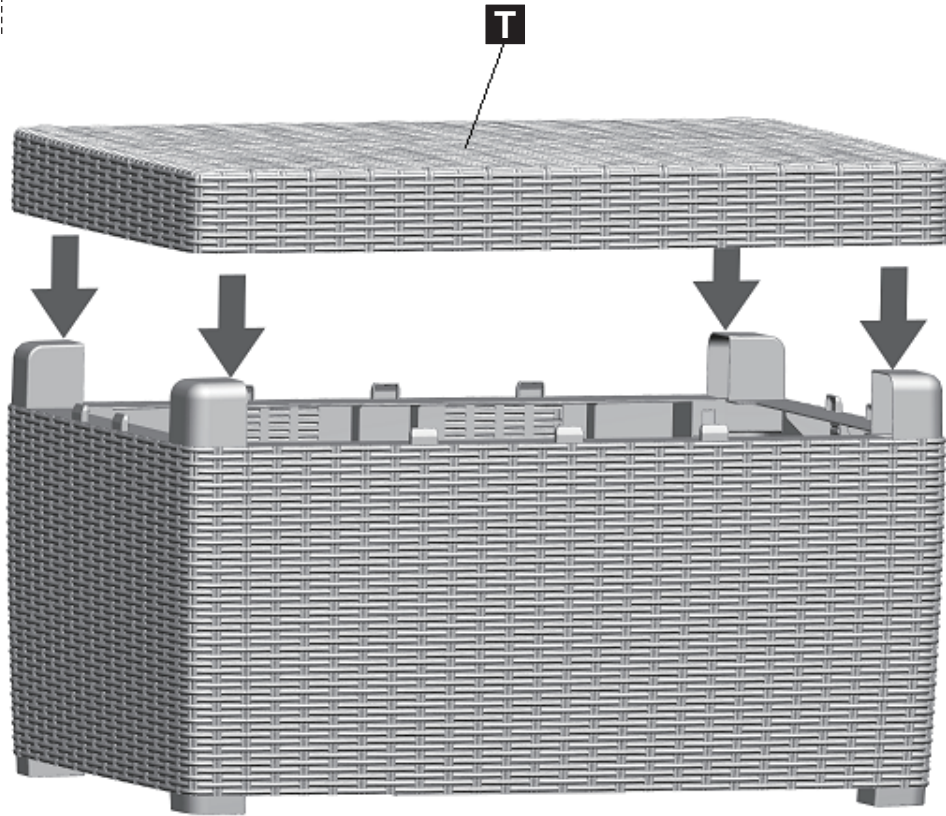
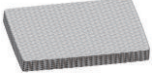

D x 4

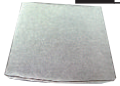

Done

**IMPORTER****EN**

MH STAR UK LTD  
Unit 27, Perivale Park, Horsenden lane South  
Perivale, UB6 7RH  
<https://www.aosom.co.uk>  
Made in China

**IMPORTATEUR****FR**

MH FRANCE  
12 Avenue Raspail 94250 Gentilly  
France  
<https://www.aosom.fr>  
Fabriqué en Chine

**IMPORTADOR POR****ES**

SPANISH AOSOM, S.L.  
C. roc gros no.15, 08550 Els hostalets de Balenya, Spain B66295775  
TEL: 931294512  
<https://www.aosom.es>  
Fabricado en China

**IMPORTEUR****DE**

MH Handel GmbH  
Wendenstraße 309 D-20537 Hamburg  
Germany  
<https://www.aosom.de>  
Hergestellt in China

**IMPORTATO DA****IT**

AOSOM Italy srl  
Centro Direzionale Milanofiori Strada 1 Palazzo F1 20090 Assago (MI)  
P.I.: 08567220960  
<https://www.aosom.it>  
Prodotto in Cina



US



001-877-644-9366  
customerservice@aosom.com

CA



001-855-537-6088  
customerservice@aosom.ca

UK



0044-800-240-4004  
enquiries@mhstar.co.uk

DE



0049-(0)40-88307530  
service@aosom.de

FR



0033-1-84166106  
contact@aosom.fr

ES



0034-931294512  
atencioncliente@aosom.es

IT



0039-0249471447  
clienti@aosom.it