

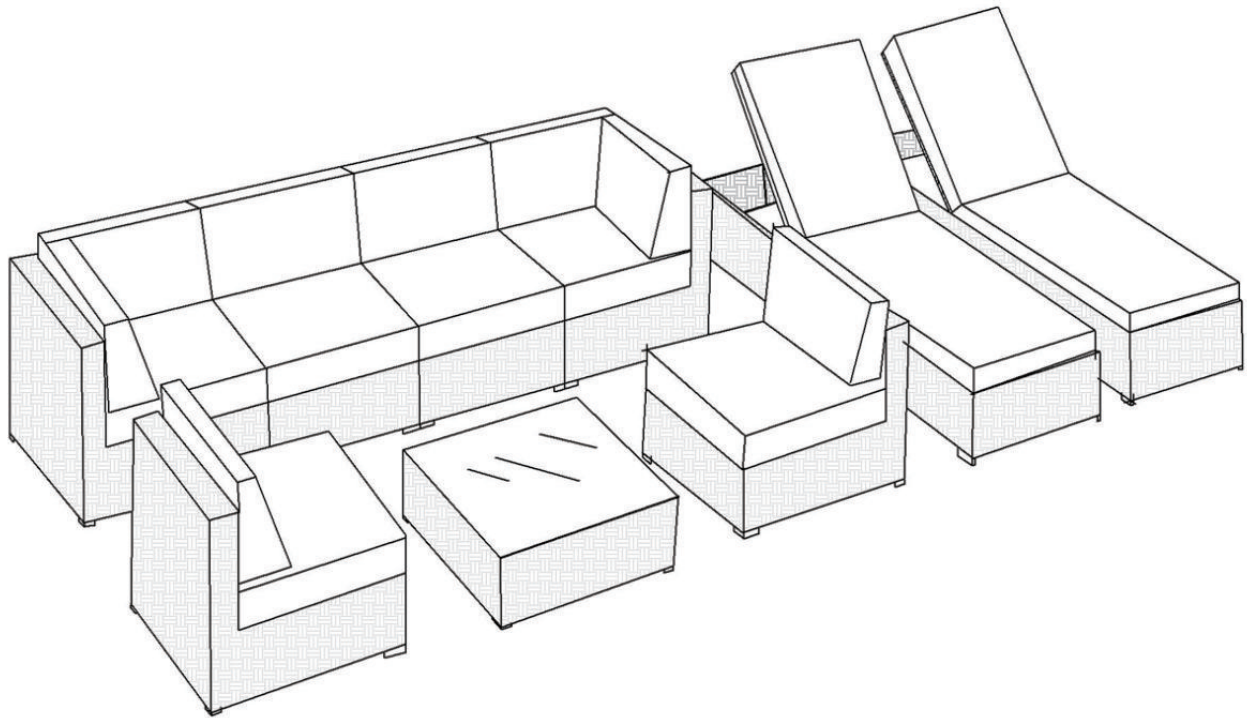

INede003V02_UK_FR_ES_DE_IT

860-018_860-041



Note : Do not tighten bolts fully until all parts are connected!

Note : Ne serrez pas les boulons à fond tant que toutes les pièces ne sont pas connectées!

Hinweis: Ziehen Sie die Schrauben erst fest an, wenn alle Teile verbunden sind!

Nota: non serrare completamente i bulloni fino a tutte le parti non sono ancora collegate!

Nota: No apriete los tornillos completamente hasta que todas las partes están conectadas!

READ AND SAVE THIS INSTRUCTIONS FOR FUTURE USE

ASSEMBLY & INSTRUCTION MANUAL

Garden Chairs

IMPORTANT, RETAIN FOR FUTURE REFERENCE:

READ CAREFULLY

Only for domestic use

Use tips:

- * Maximum Weight Capacity of Chair: 180 Kg
- * Maximum Weight Capacity of Table: 50 Kg
- * Put the chair stably on a flat floor.
- * Mount the garden chairs in the shelter of the weather.
- * Stay away from open flames.
- * Don't hang anything in the structure.
- * Avoid the overload at the anchors/structure.
- * It is advised that don't stay on the chairs when there is a storm.
- * Do not use in adverse weather condition and cover furniture when not in use.

Precautions before assembly:

- * Prepare a clean and dry mounting area.
- * Verify that the product is not damaged.
- * Check that none of the pieces are missing.

Maintenance:

- * Clean with a soft fabric.
- * Regularly remove leaves and / or water collected on the canvas.
- * Check the chair regularly.

Storage conditions:

* The fabric should be stored completely dry, in a clean and dry place to avoid the risks of mold.

Caution with the risks of pinching or cuts during assembly.

The manufacturer declines all responsibility in case of damages due to a bad installation or due to weather.

Chaises de jardin

IMPORTANT - CONSERVEZ CES INFORMATIONS POUR VOTRE CONSULTATION ULTÉRIEURE: LISEZ ATTENTIVEMENT

Seulement pour usage domestique

Conseils:

- * Poids maximum admissible de la chaise: 180 Kg
- * Poids maximal admissible de la table: 50 Kg
- * Pour une performance optimale, veuillez le poser sur une surface plane.
- * Installer la chaise sous l'auvent.
- * Maintenez à l'écart de toute flamme nue.
- * Évitez de suspendre des matériaux sur le meuble.
- * Veuillez à ne pas dépasser les capacités de poids maximales.
- * Il est conseillé de ne pas rester sur la chaise en cas d'orage.
- * Ne pas utiliser dans des conditions météorologiques défavorables et couvrir les meubles lorsqu'ils ne sont pas utilisés.

Précautions avant l'assemblage:

- * Préparez une zone de montage propre et sèche.
- * Vérifiez que le produit n'est pas endommagé.
- * Vérifiez qu'aucun des morceaux ne manque.

Recommandations d'entretien:

- *Veuillez utiliser un chiffon doux pour essuyer la chaise.
- *Veuillez nettoyer régulièrement l'eau stagnante du fauteuil
- *Veuillez vérifier régulièrement la chaise pour éviter une structure lâche.







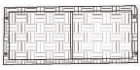

Conditions de stockage:

- *Lorsqu'ils ne sont pas utilisés, les meubles doivent être recouverts d'une housse appropriée.

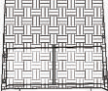

Veuillez faire attention à ne pas vous blesser lors de l'assemblage du produit.

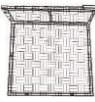
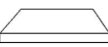
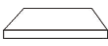
Le fabricant n'est pas responsable des dommages causés par une mauvaise installation.

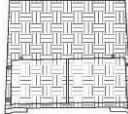

BOX-1/7

NO.	PARTS	QTY
G		2
J		1
K		1
L		1
M		1
N		1
O		1
R		2
Q		2
2		2
A ↓ P		1

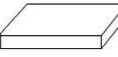
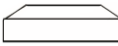

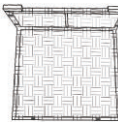
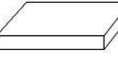
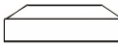

BOX-2/7

NO.	PARTS	QTY
F		2
G		4
E		2
H		1
I		2

BOX-3/7

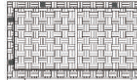
NO.	PARTS	QTY
F		2
G		4
E		2
H		1
I		2







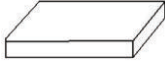

BOX-4/7

NO.	PARTS	QTY
A		2
B		2
C		1
D		1
H		2

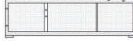

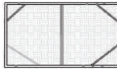



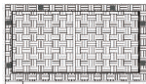

BOX-5/7









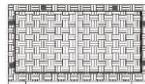

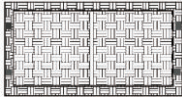

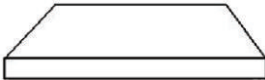
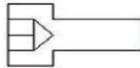

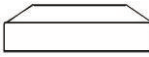
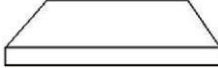

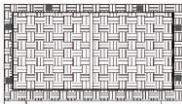
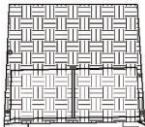



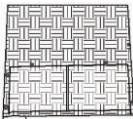
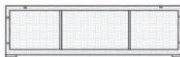

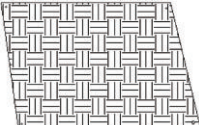
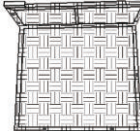
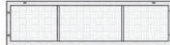

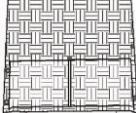
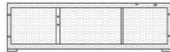
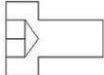
NO.	PARTS	QTY
P		2

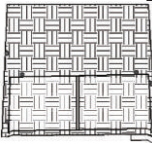
BOX-6/7

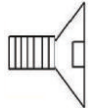
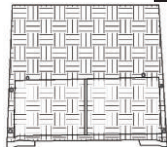
NO.	PARTS	QTY
S		2
T		1
U		1
V		1
W		1
X		1
Y		1
Z		1
A1		1
B1		1

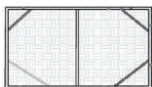
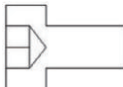
BOX-7/7

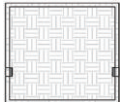
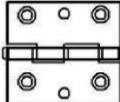
NO.	PARTS	QTY
S		2
T		1
U		1
V		1
W		1
X		1
Y		1
Z		1
A1		1
B1		1

A x 2 	H x 4 	Q x 2 	a x 68 
A1 x 2 	I x 4 	R x 2 	b x 46 
B x 2 	J x 1 	S x 4 	c x 136 
B1 x 2 	K x 1 	T x 2 	e x 50 
C x 1 	L x 1 	U x 2 	h x 44 
D x 1 	M x 1 	V x 2 	j x 8 
E x 4 	N x 1 	W x 2 	o x 16 
F x 4 	O x 1 	X x 2 	p x 4 
G x 10 	P x 2 	Y x 2 	1 x 4 
		Z x 2 	2 x 2 

A x 2

B x 1

a x 4

c x 4

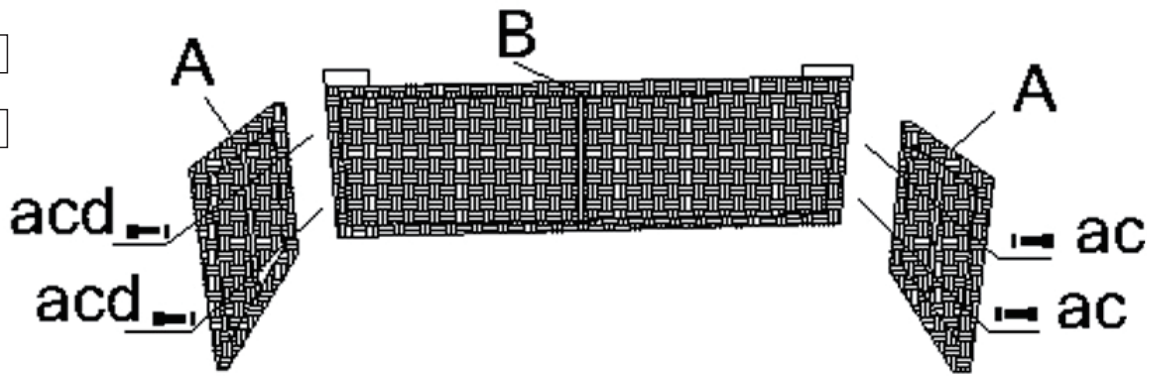

B x 1

a x 4

c x 4

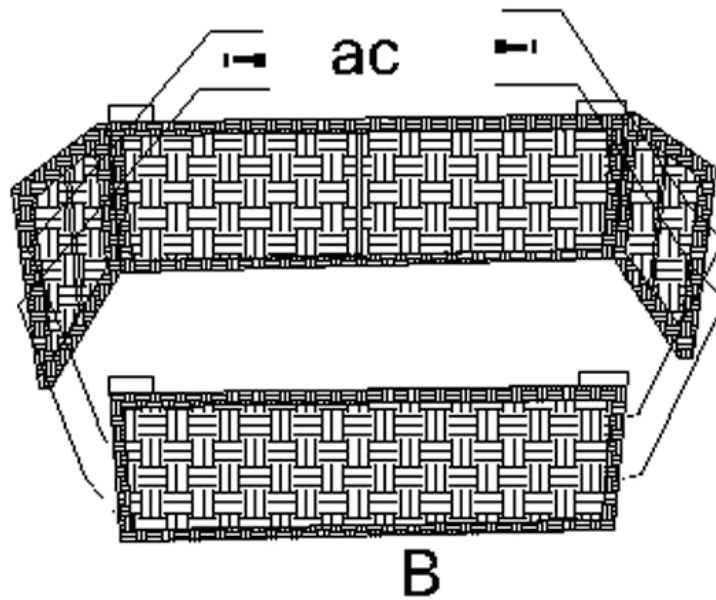

C x 1

a x 4

c x 4

h x 4

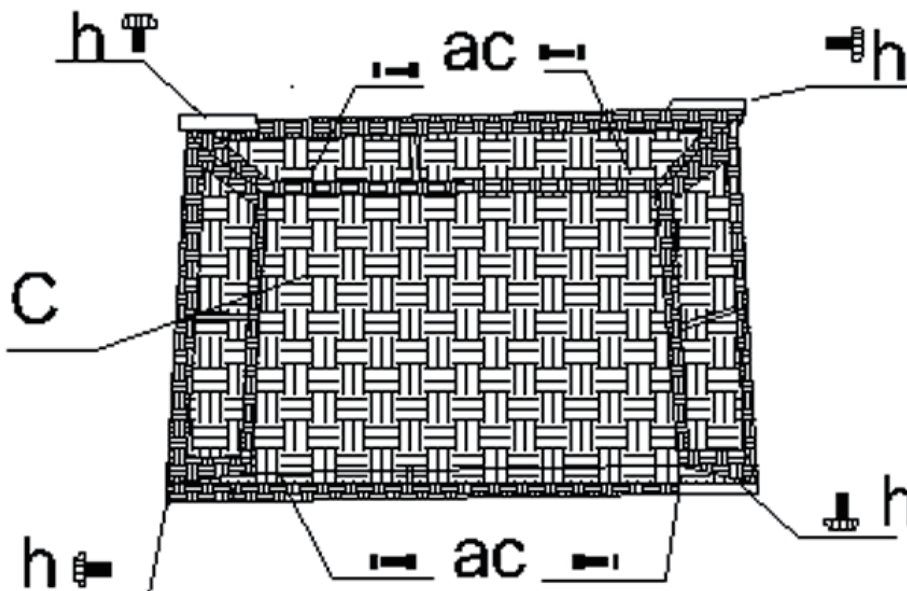

D x 1

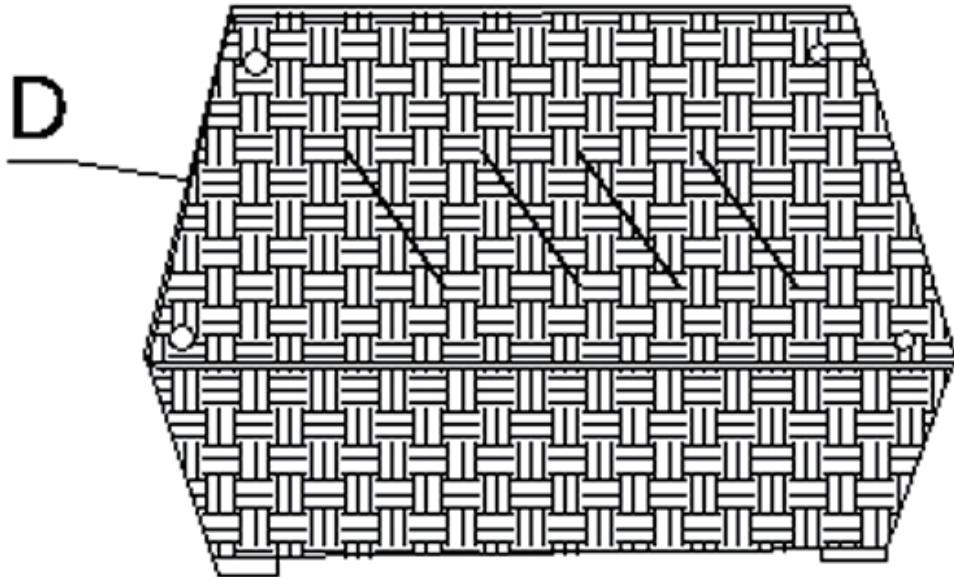

E x 1

F x 1

b x 2

c x 4

e x 2

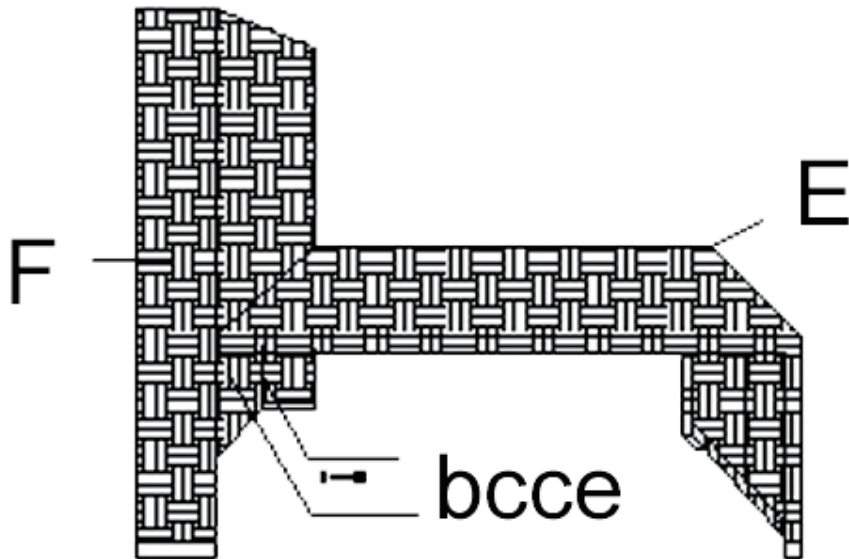

x4

G x 1

a x 2

b x 2

c x 6

e x 2

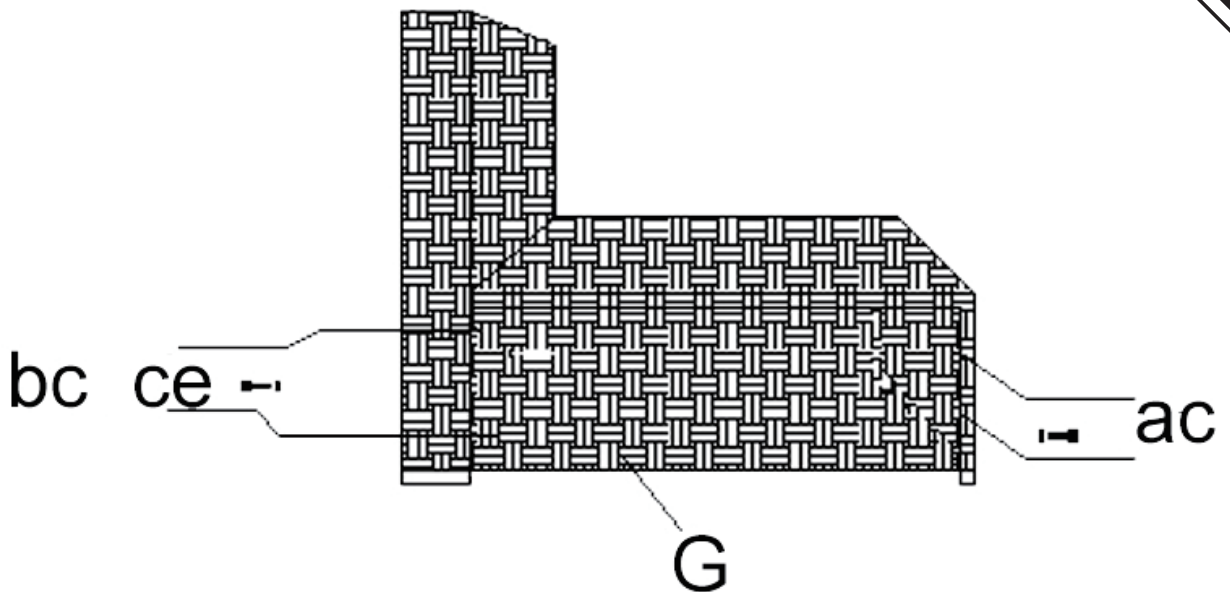

x4

G x 1

a x 2

b x 2

c x 6

e x 2

ac

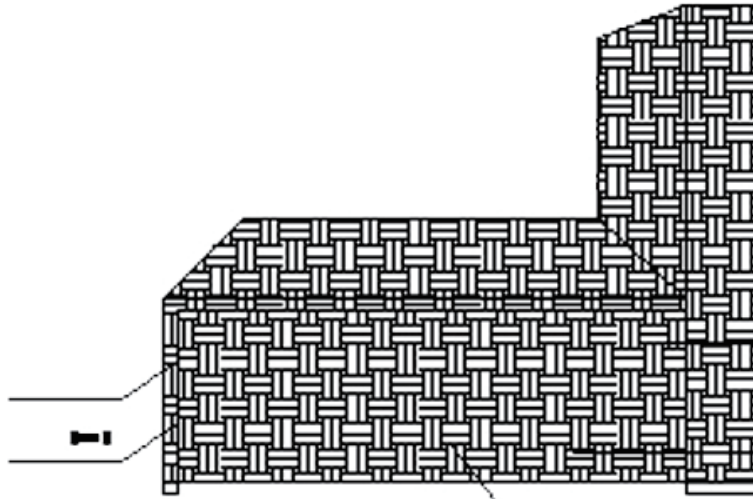

bc ce

G

x4

H x 1

I x 1

h x 4

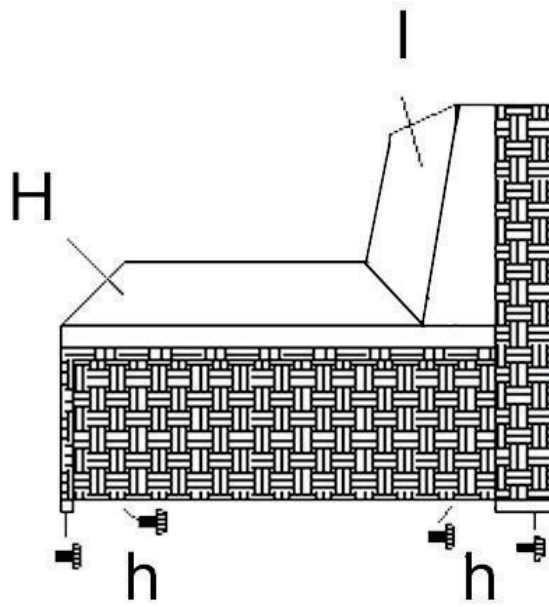

H

I

h

h

x4

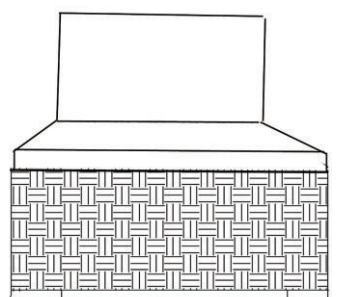
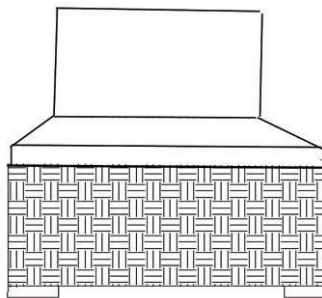
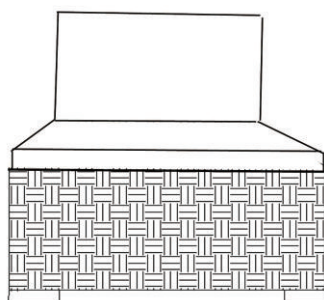
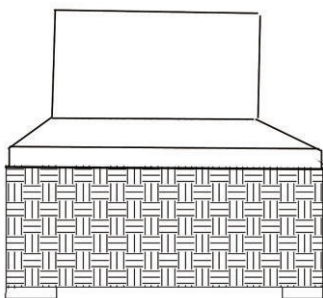

J x 1

K x 1

a x 1

b x 1

c x 4

e x 1

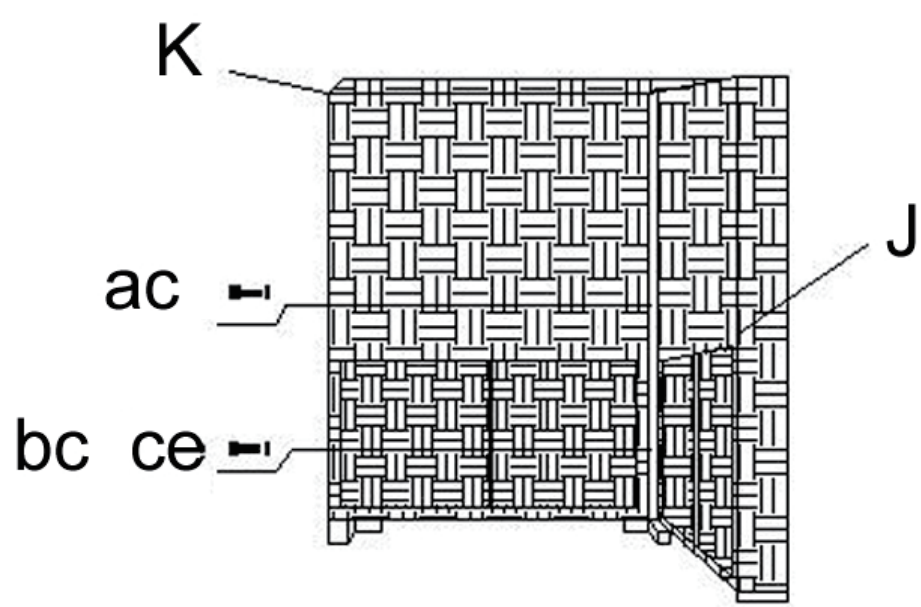

L x 1

a x 1

b x 4

c x 8

e x 4

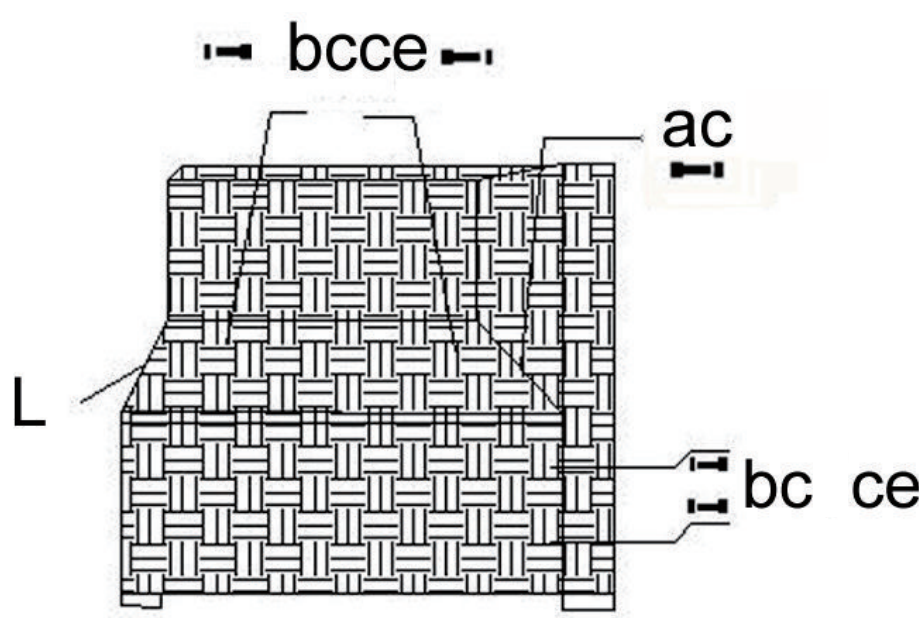

G x 1

a x 2

b x 2

c x 6

e x 2

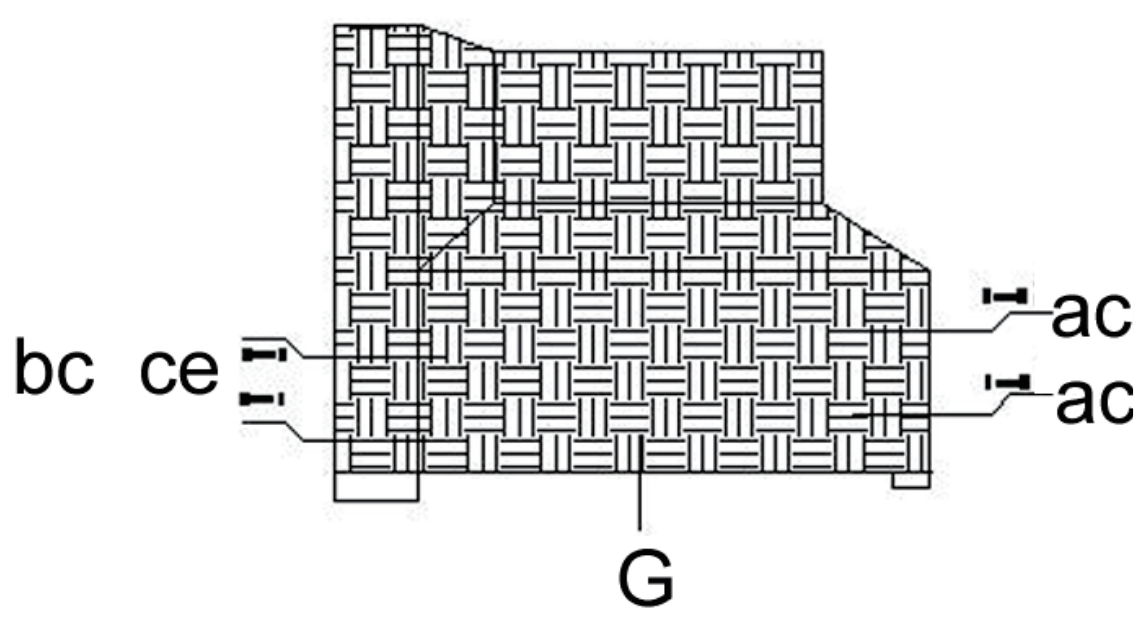

P x 1

Q x 1

R x 1

h x 4

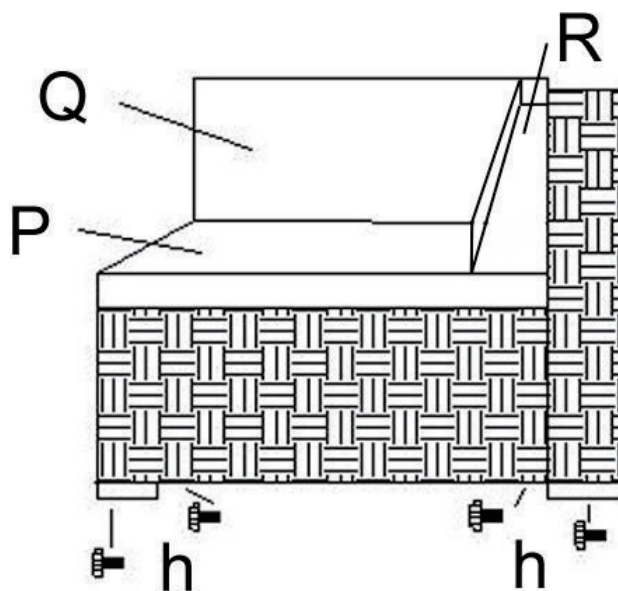

M x 1

N x 1

a x 1

b x 1

c x 3

e x 1

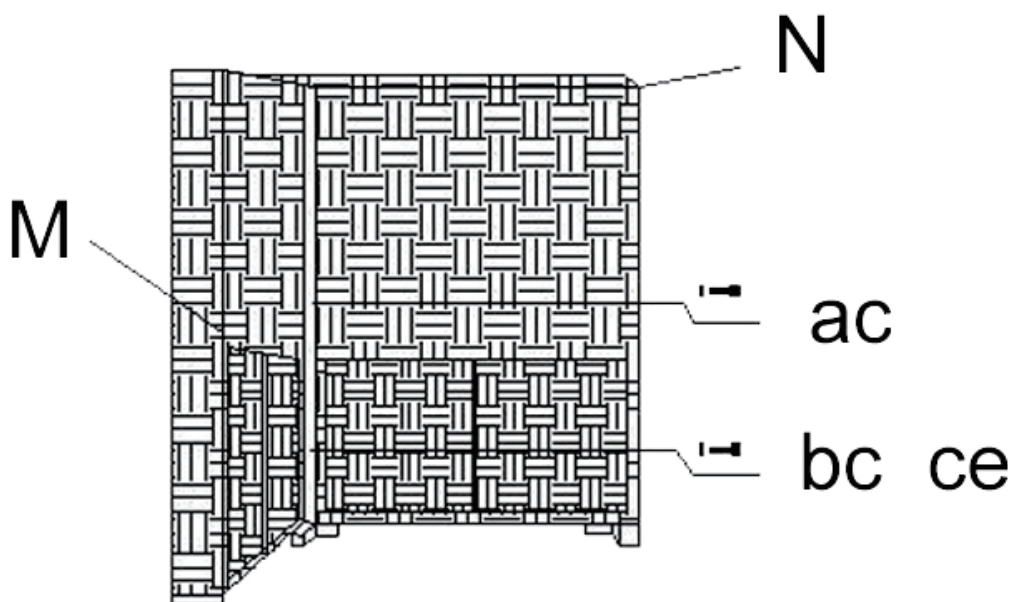

O x 1

a x 1

b x 4

c x 9

e x 4

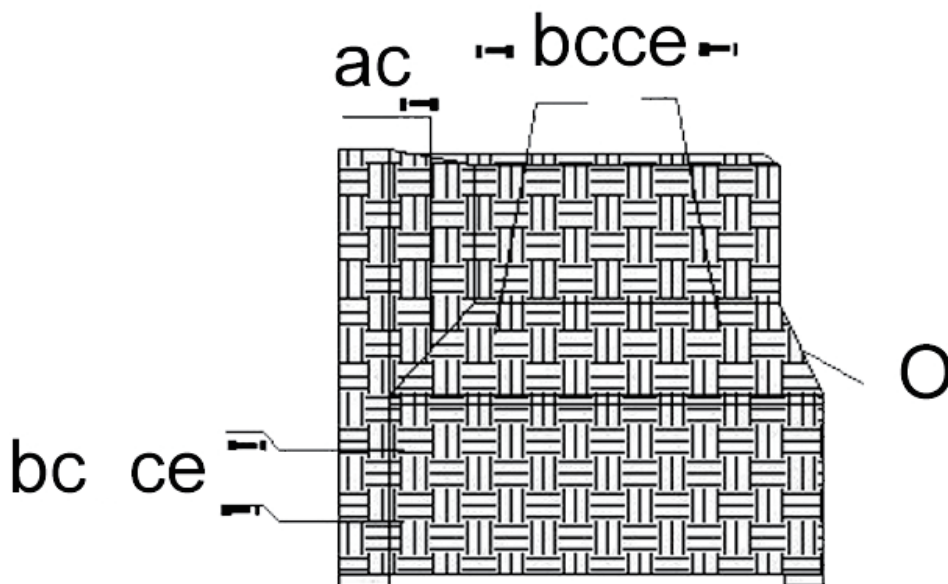

G x 1

a x 2

b x 2

c x 6

e x 2

ac

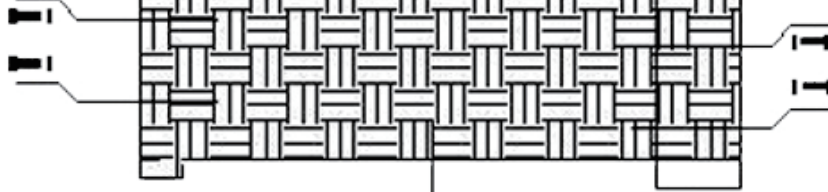

G

bc ce

Q x 1

R x 1

P x 1

h x 4

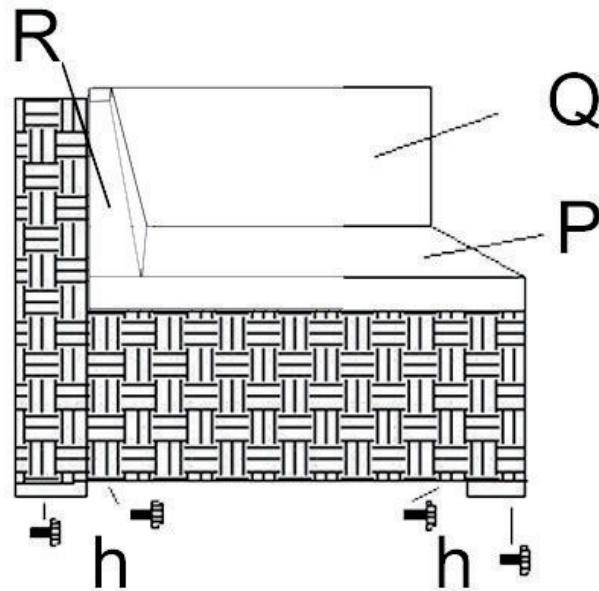

h

h

T x 1

U x 1

V x 1

W x 1

b x 4

c x 8

e x 4

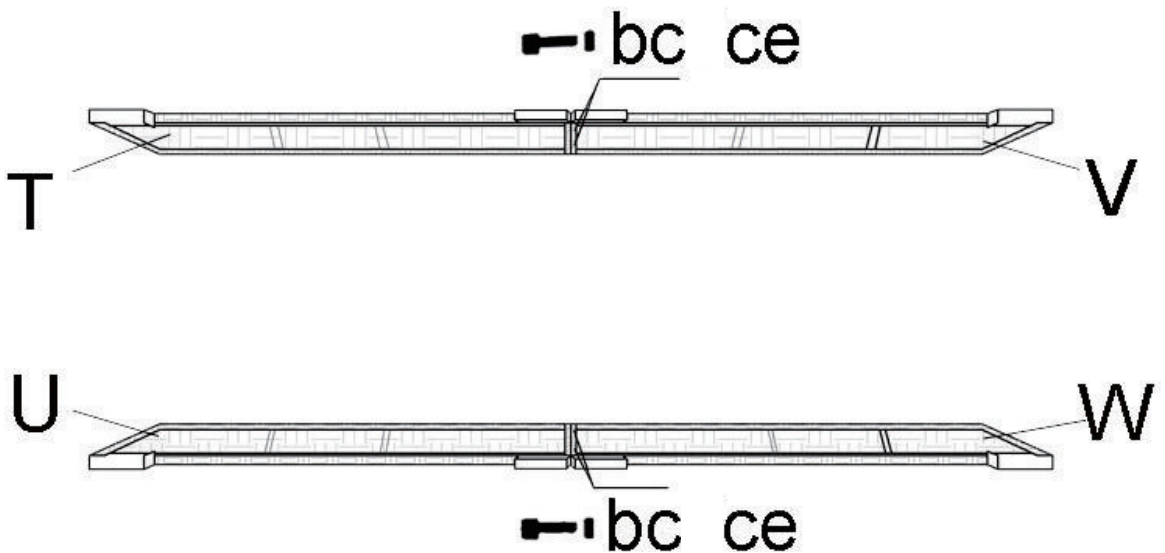

bc ce

T

V

U

W

bc ce

x2

S x 2

a x 8

c x 8

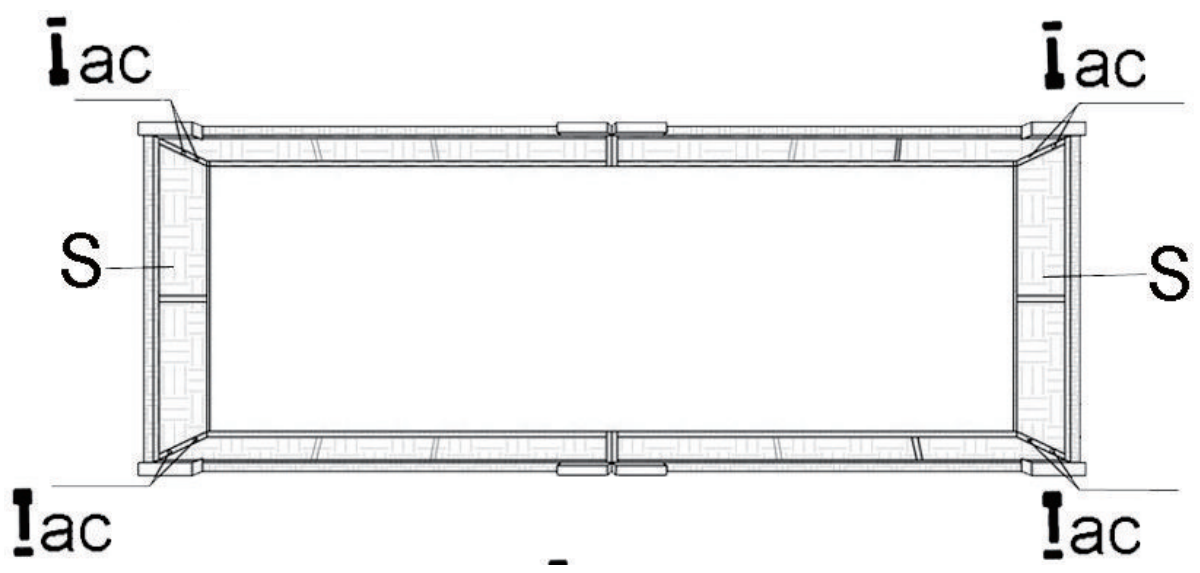

x2

X x 1

A1 x 1

a x 8

c x 12

j x 4

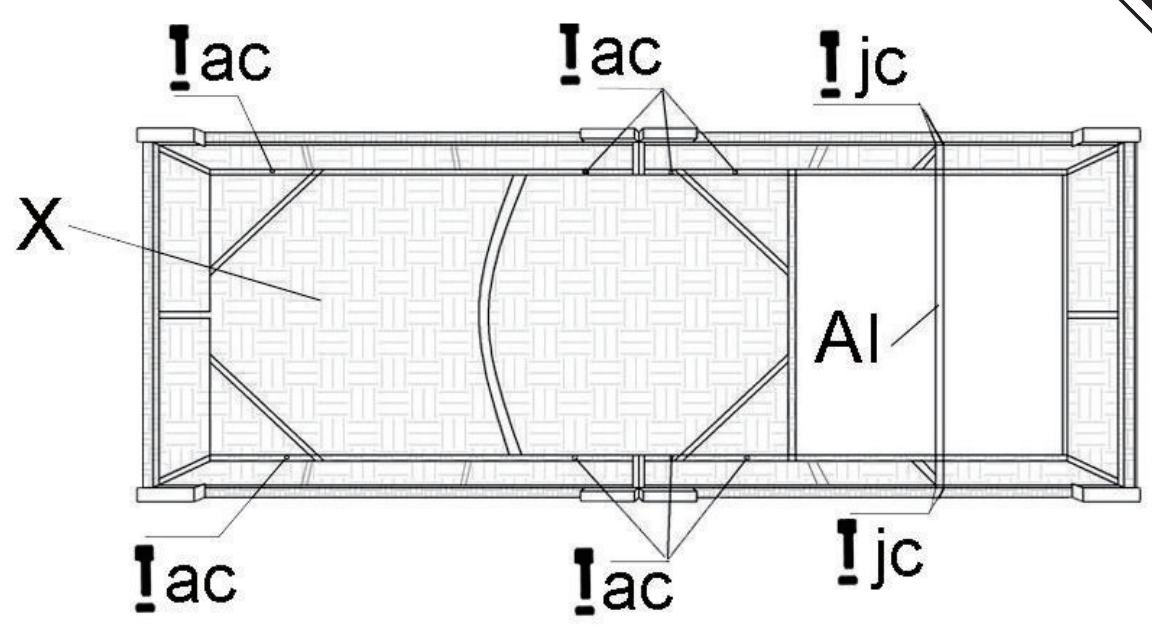

x2

Y x 1

Z x 1

c x 4

h x 8

e x 2

o x 8

p x 2

1 x 2

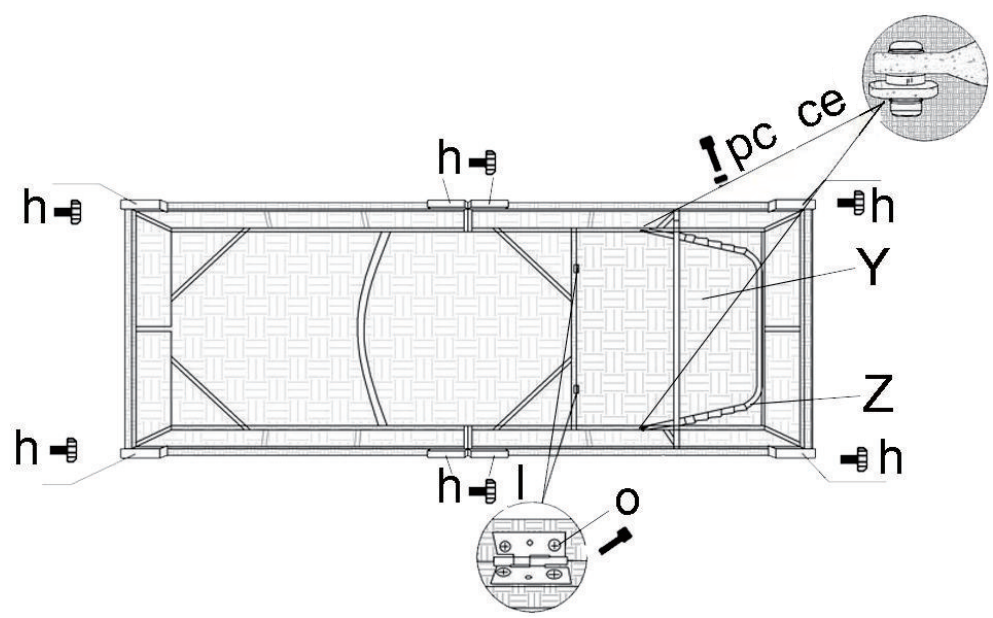

x2

