













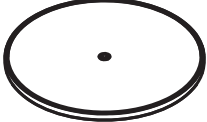

INegd004_GL

867-064

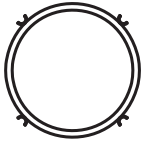

READ AND SAVE THIS INSTRUCTIONS FOR FUTURE USE

ASSEMBLY & INSTRUCTION MANUAL

 <p>A x 1</p>	 <p>E x 8</p>	 <p>I x 8</p>
 <p>B x 4</p>	 <p>F x 8</p>	 <p>J x 1</p>
 <p>C x 1</p>	 <p>G x 8</p>	 <p>K x 1</p>
 <p>D x 1</p>	 <p>H x 16</p>	 <p>L x 4</p>

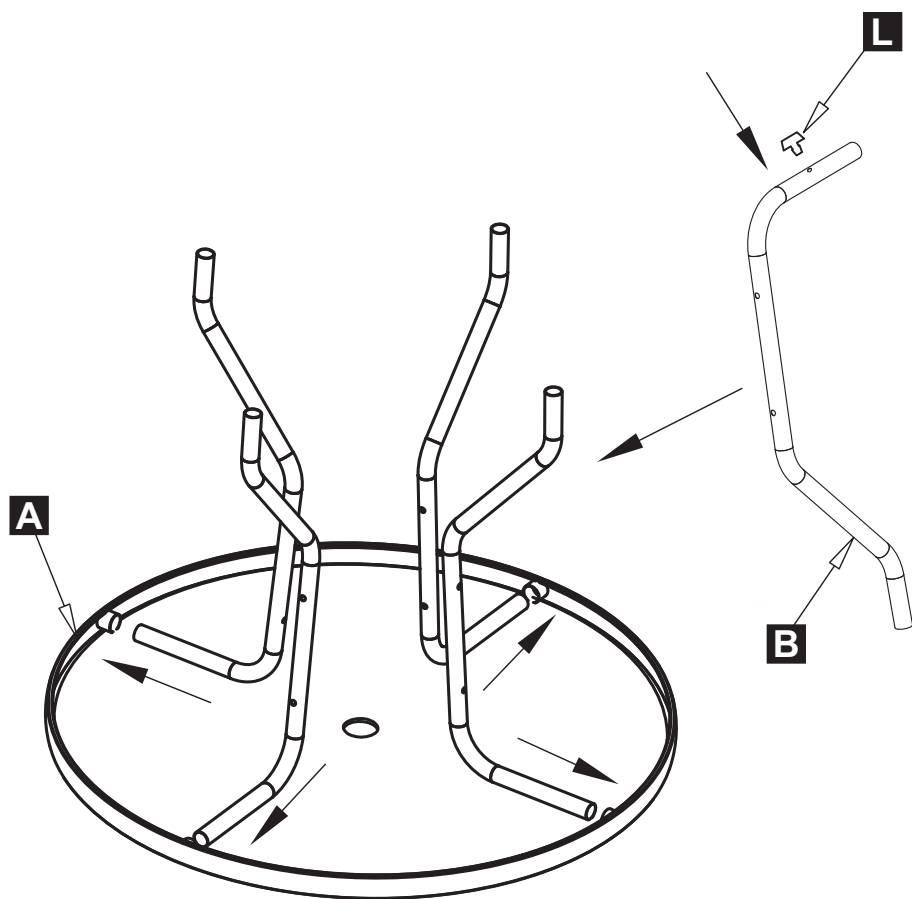

E x 8

F x 8

G x 8

H x 16

I x 8

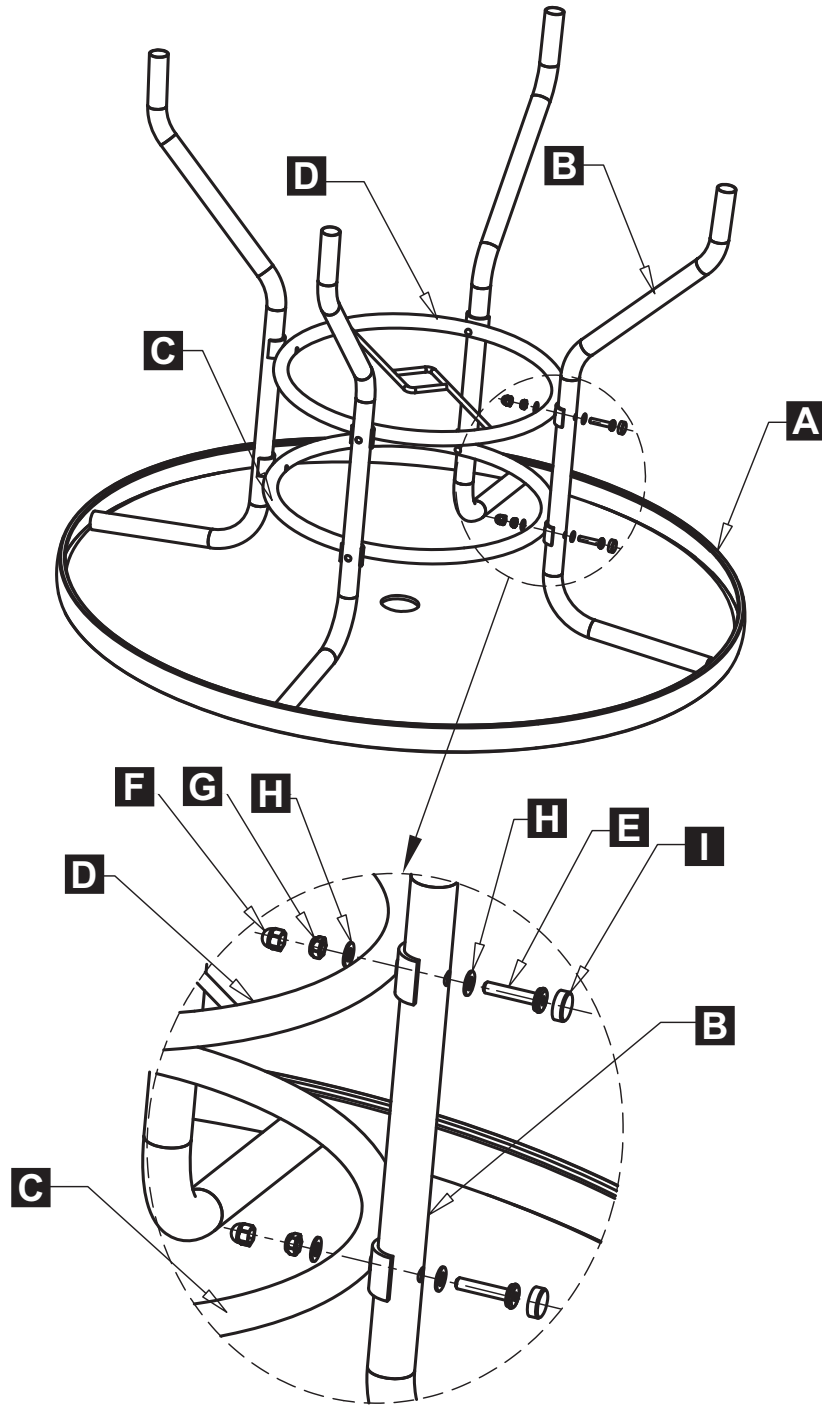

US



001-877-644-9366
customerservice@aosom.com

CA



001-855-537-6088
customerservice@aosom.ca

UK



0044-800-240-4004
enquiries@mhstar.co.uk

DE



0049-(0)40-88307530
service@aosom.de

FR



0033-1-84166106
contact@aosom.fr

ES



0034-931294512
atencioncliente@aosom.es

IT



0039-0249471447
clienti@aosom.it