

- * Suitable for children of 3-8 years old.
- * Max weight: 50 kg.
- * Convient aux enfants de 3 à 8 ans.
- * Poids maximum : 50 kg.
- * Geeignet für Kinder im Alter von 3-8 Jahren.
- * Max. Gewicht: 50 kg.
- * Adecuado para los niños de 3 a 8 años.
- * Peso máximo: 50 kg.
- * Adatto a bambini di 3-8 anni.
- * Peso massimo: 50 kg.



IMPORTANT, RETAIN FOR FUTURE REFERENCE: READ CAREFULLY

ASSEMBLY INSTRUCTION

⚠ WARNING: CHOKING HAZARD—Small parts. Not for children under 3 years. Only allowed for adults to install, keep children away.







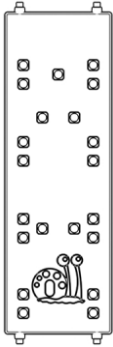
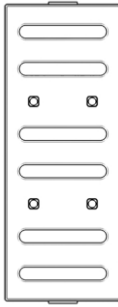
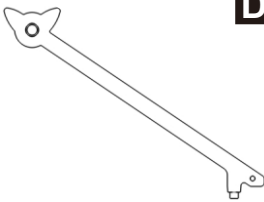
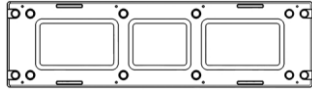
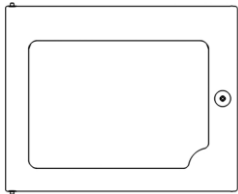
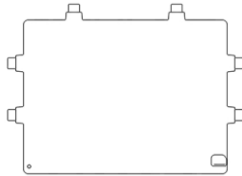

⚠ Warnung: Es gibt Kleinteile, die für Kinder unter 3 Jahren gefährlich sein können. Nur für Erwachsene installieren, Kinder fernhalten.

⚠ Attention: Contient de petites pièces pouvant être dangereux pour les enfants moins de 3 ans. Seulement autorisé pour les adultes à installer, éloigner les enfants.

⚠ Advertencia: Las piezas pequeñas contienen que pueden ser peligrosas para niños menores de 3 años. Solo se permite la instalación de adultos. Mantenga a los niños alejados.

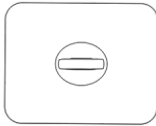
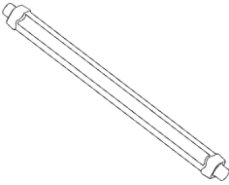
⚠ Attenzione: Il prodotto contiene piccoli apparecchi che possono essere pericolosi a bambini inferiore ai 3 anni. Consentito solo agli adulti di installare, tenere lontano i bambini.

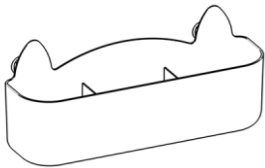
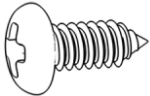
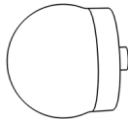
PART LIST

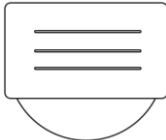
A x 3 	C x 1 	D x 4 	E x 2 
		F x 3 	G x 2 
	H x 1 	I x 2 	J x 2 
K x 2 		L x 3 	M x 44 +2(spare) 
N x 3 		O x 3 	P x 3 
	Q x 1 		R x 1 

O x 3

01

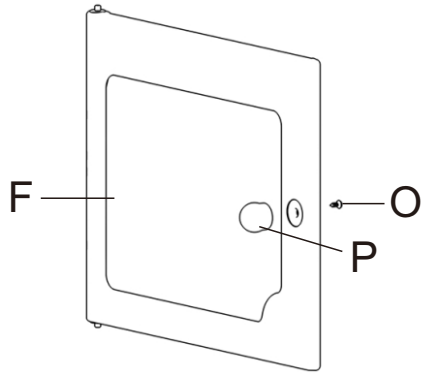

02

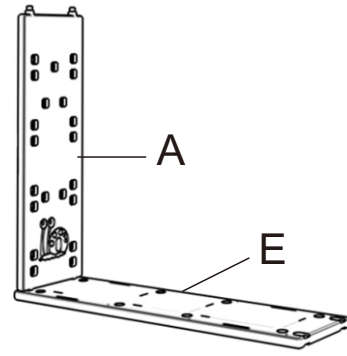

x3

03

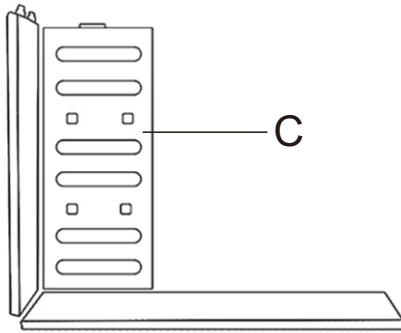

04

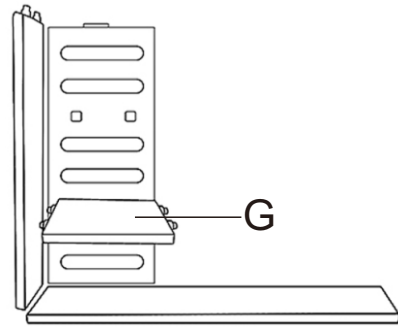

05

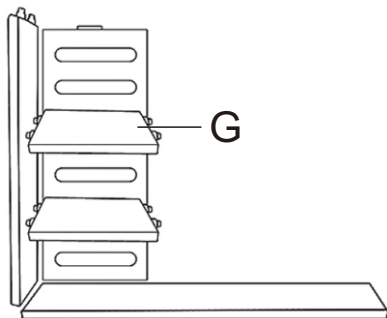

06

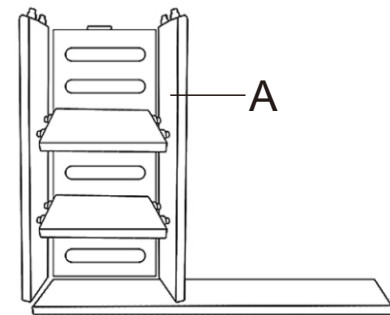

07

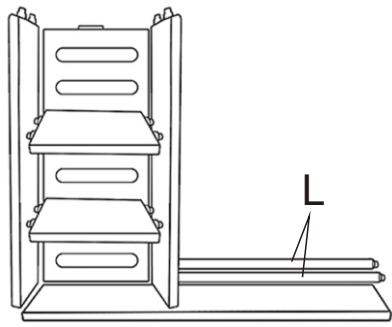

08

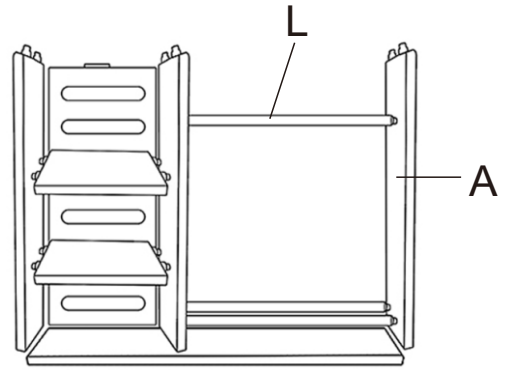

09

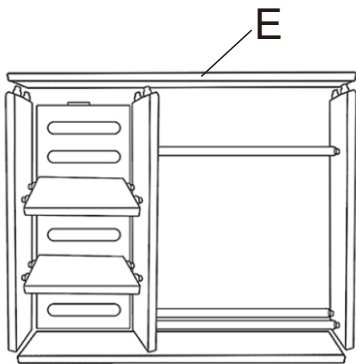

10

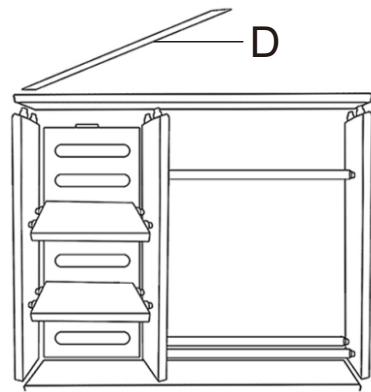

11

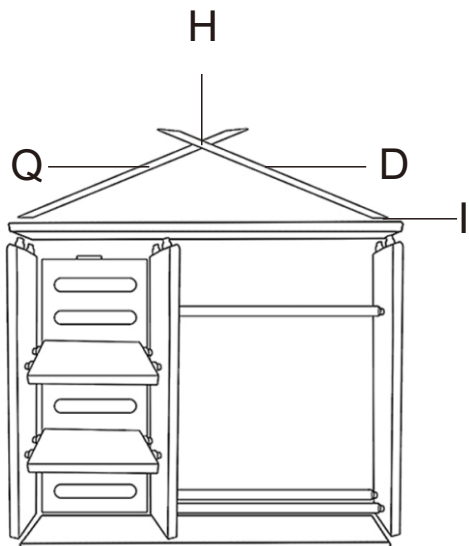

12

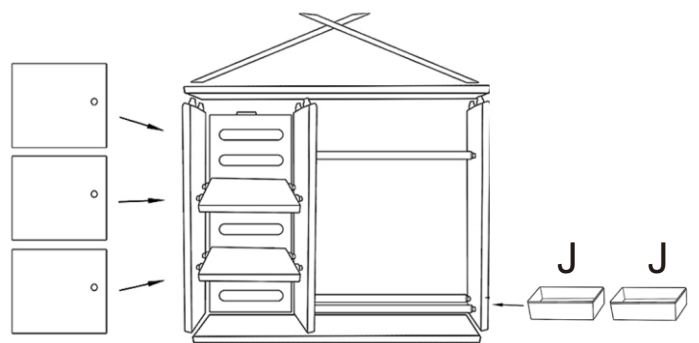

US



001-877-644-9366
customerservice@aosom.com

CA



001-855-537-6088
customerservice@aosom.ca

UK



0044-800-240-4004
enquiries@mhstar.co.uk

DE



0049-(0)40-88307530
service@aosom.de

FR



0033-1-84166106
contact@aosom.fr

ES



0034-931294512
atencioncliente@aosom.es

IT



0039-0249471447
clienti@aosom.it