**Assembly instructions**

- Please check if there are any omissions in the instructions
- Please pay attention to the precautions when assembling



**IMPORTANT, RETAIN FOR FUTURE REFERENCE: READ CAREFULLY**

# ASSEMBLY INSTRUCTION

● **Accessory name**

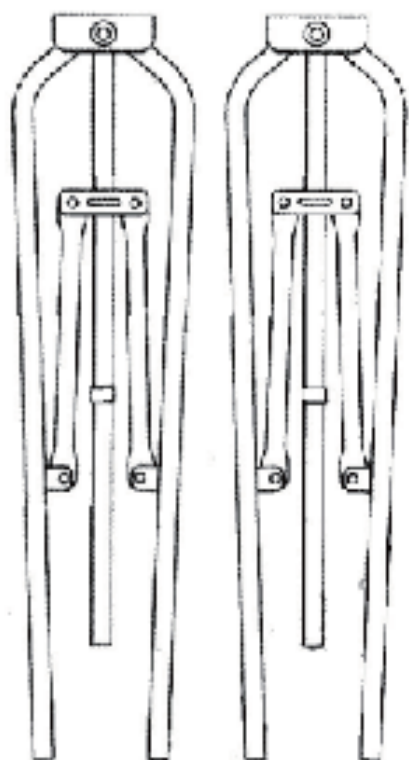

Main shelf: 2parts



Knob: 2pcs



Adjustment lever: 2pcs



Adjustment disc: 2pcs

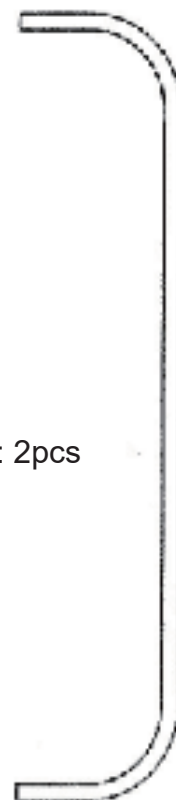

Single lever: 1pcs

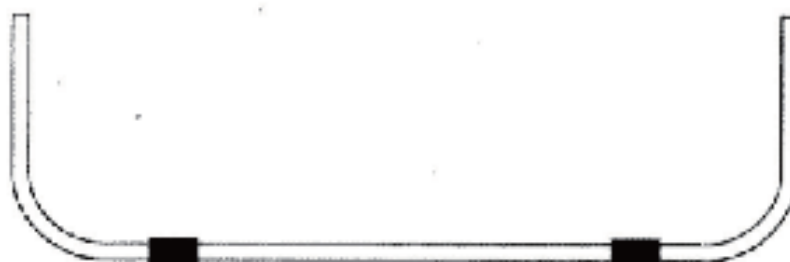

Base lever: 2pcs



Scerw: 10pcs+spare 1pc

## ● Accessory name

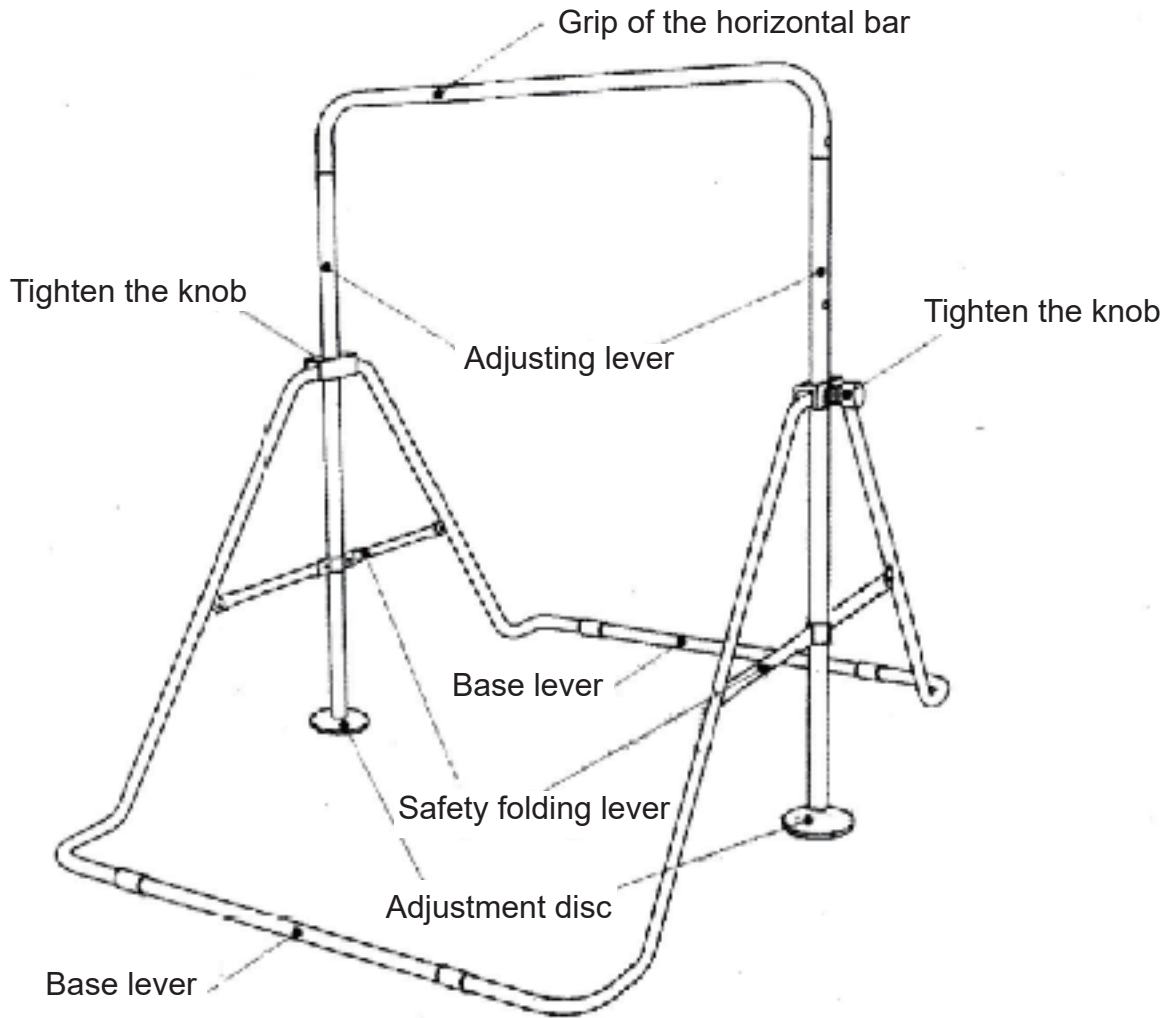

## ● Way of assembly

To ensure safety, it is recommended that 2 people assemble at the same time.

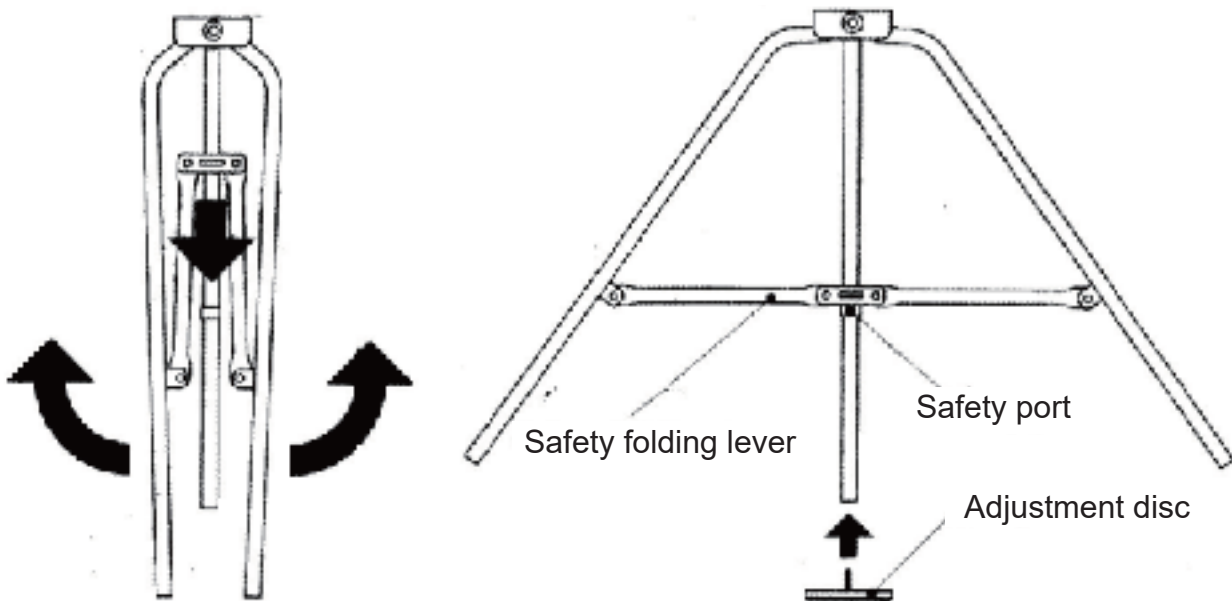

Open the main shelf, screw on the adjusting disc after unfolding (as shown in the figure)

## • Way of assembly

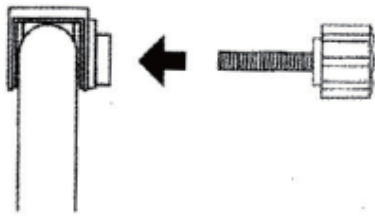

Connect the knob and tighten

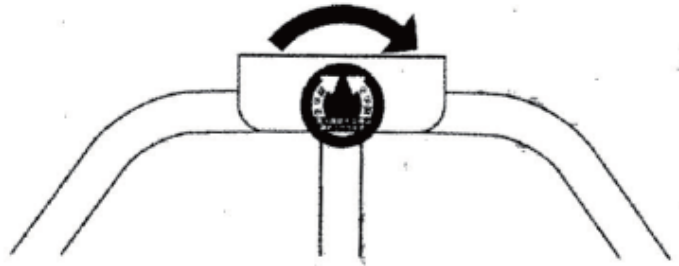

Tighten the knob

Tighten the knob

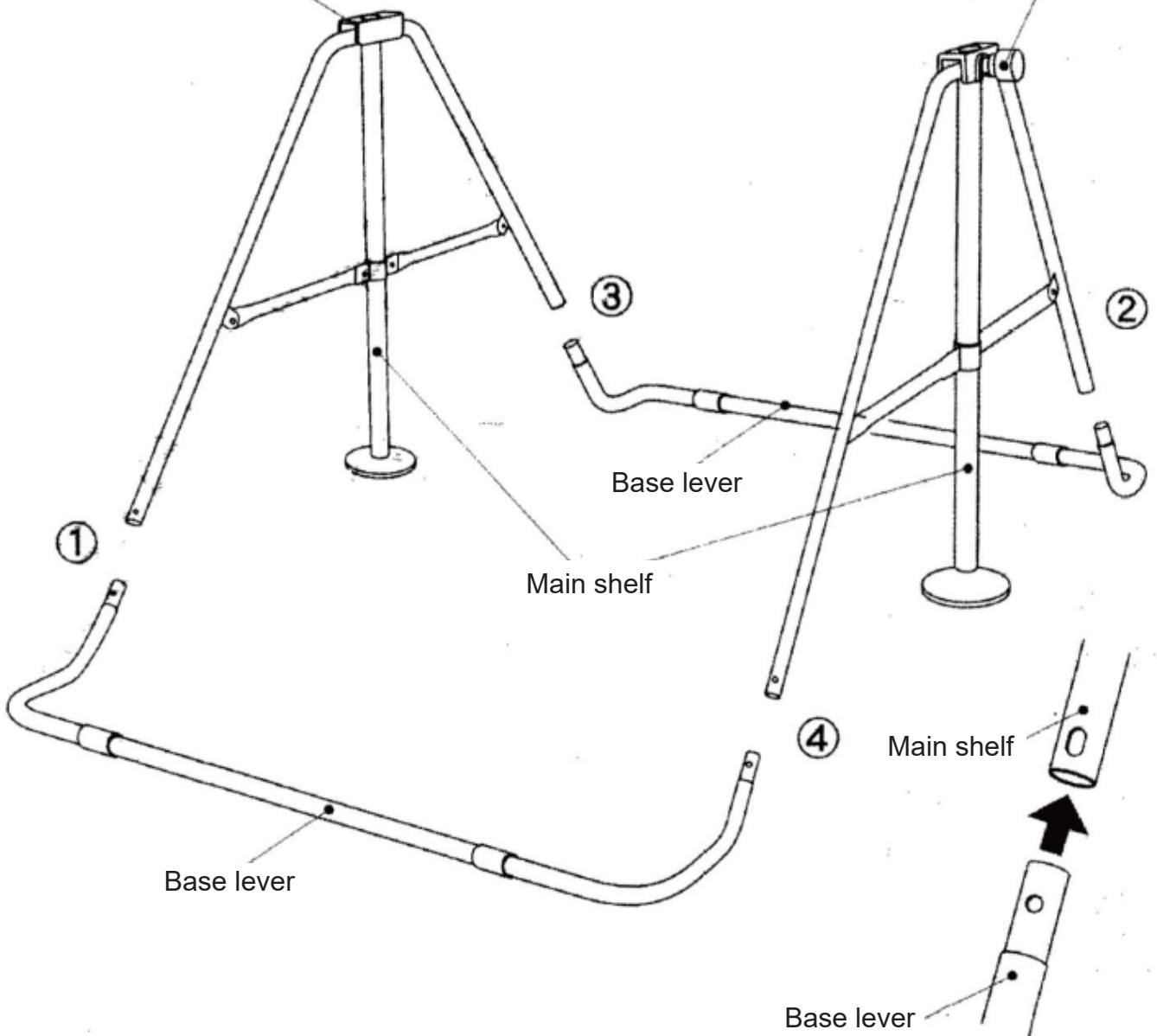

Important: In the direction of the main lever, the tightening knob needs to face the outside, otherwise the horizontal lever cannot be installed with screws. Connect the accessories and tighten the screws.

## • Way of assembly

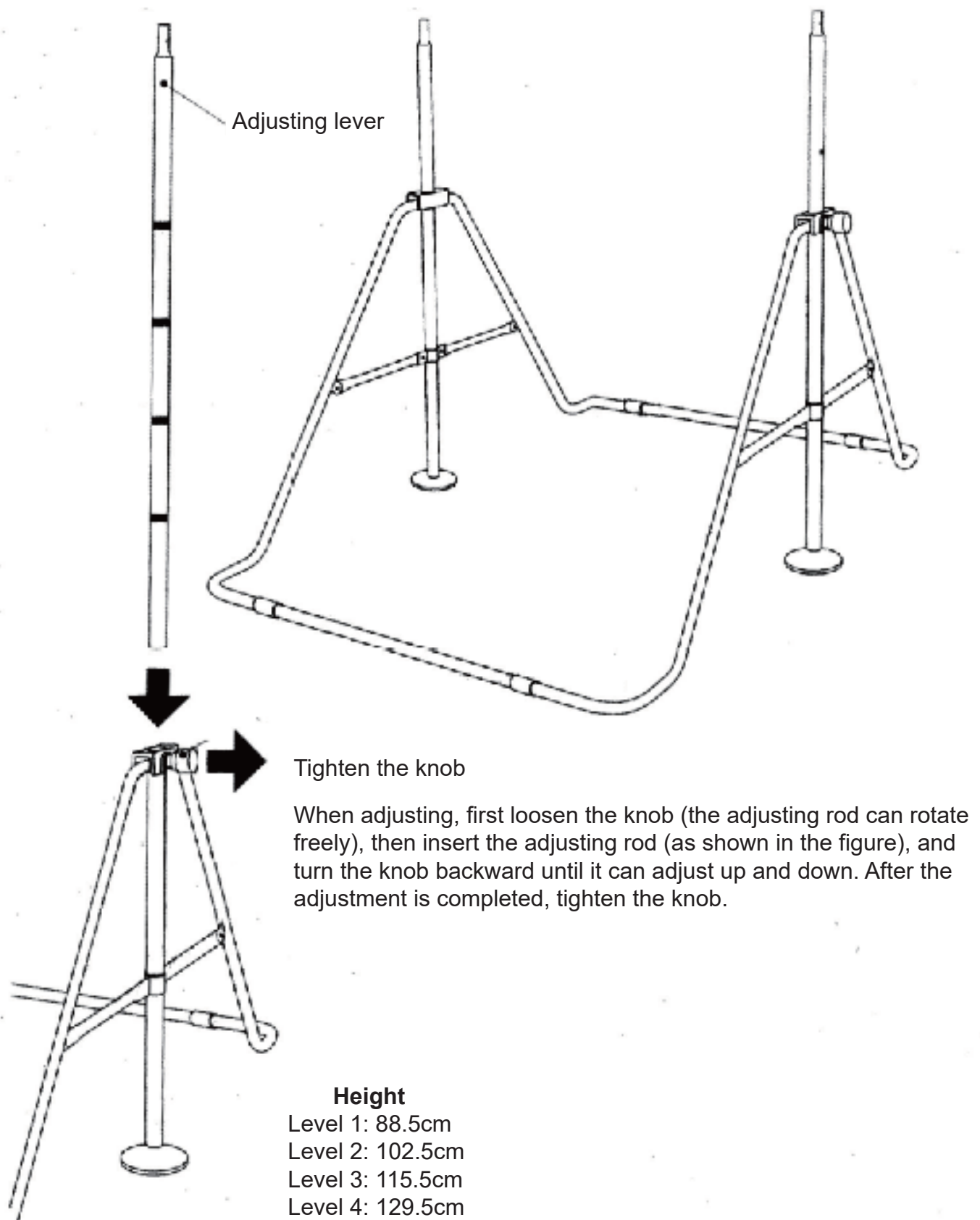

## • Way of assembly

### Adjustment guidelines

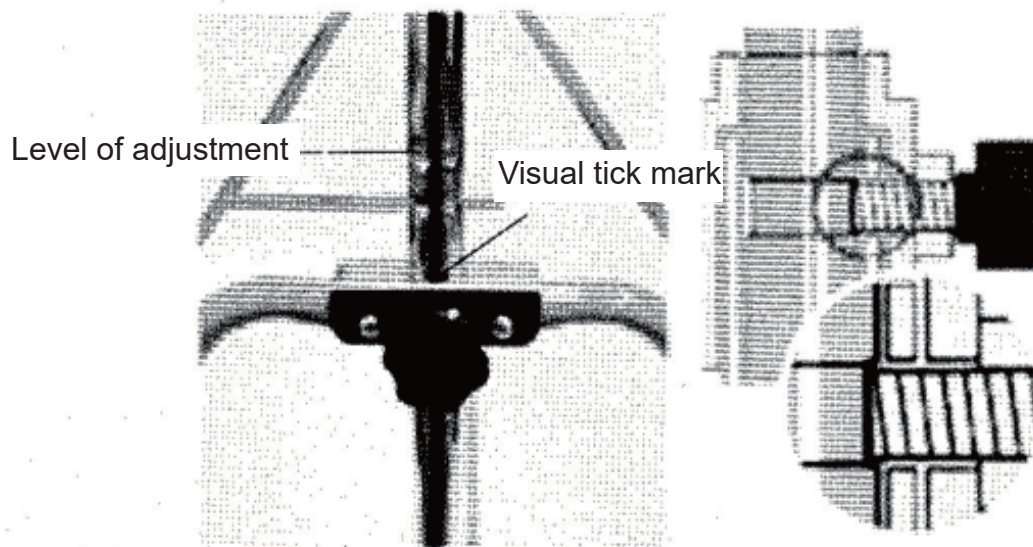

Loosen the knob first, put the adjusting lever into a suitable height and tighten it.

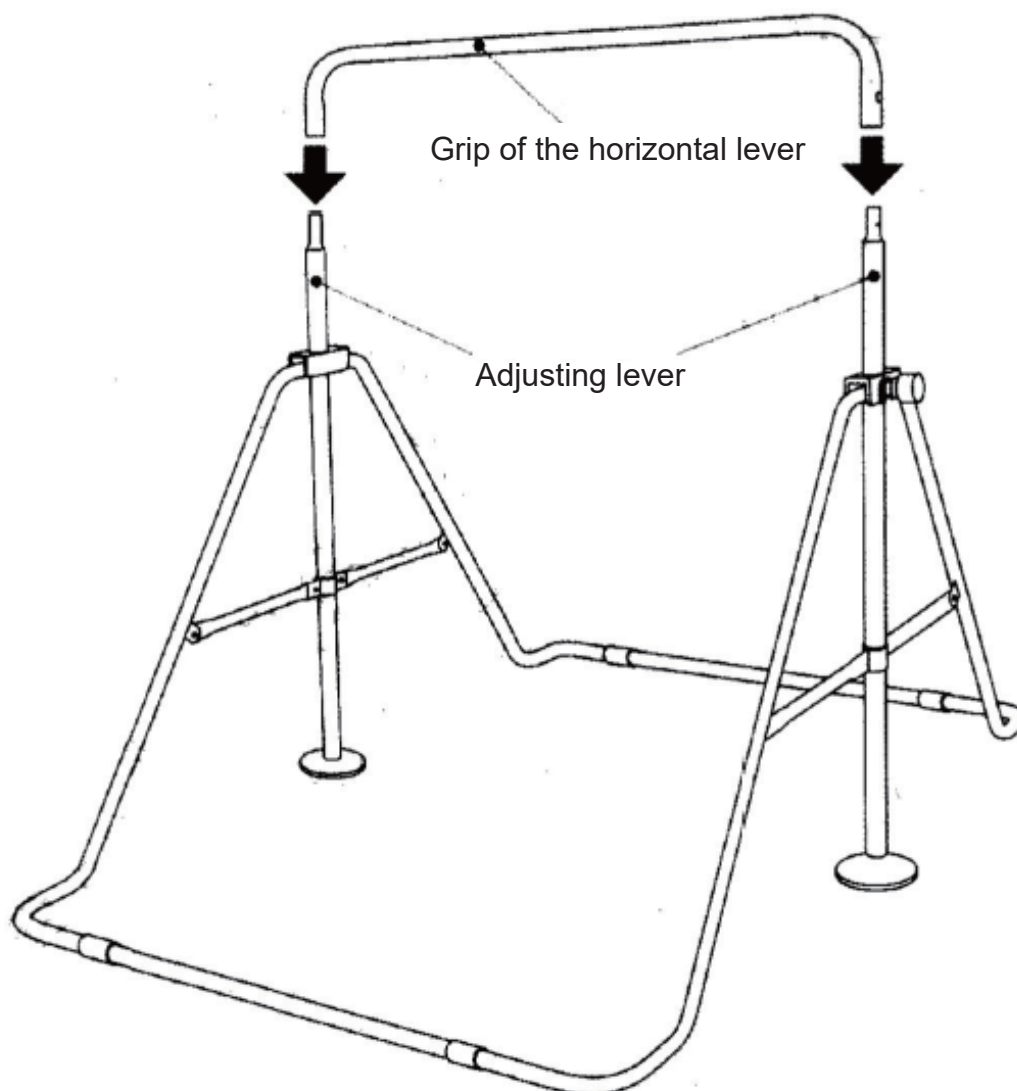

The grip of the horizontal lever is combined with the adjustment bar and locked with screws  
Note: The adjustment knob needs to face outwards, if the adjustment knob faces inward, there will be no corresponding holes.

## • Height adjustment

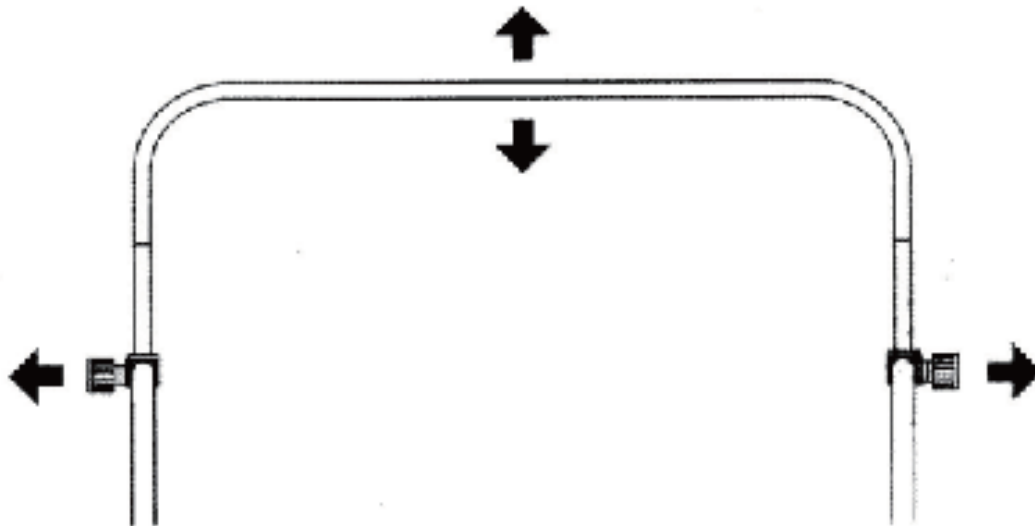

Left and right adjustment knobs: Loosen the knobs on the 2 sides first, when the adjustment lever can be turned, you can adjust the height, and then tighten the knob.

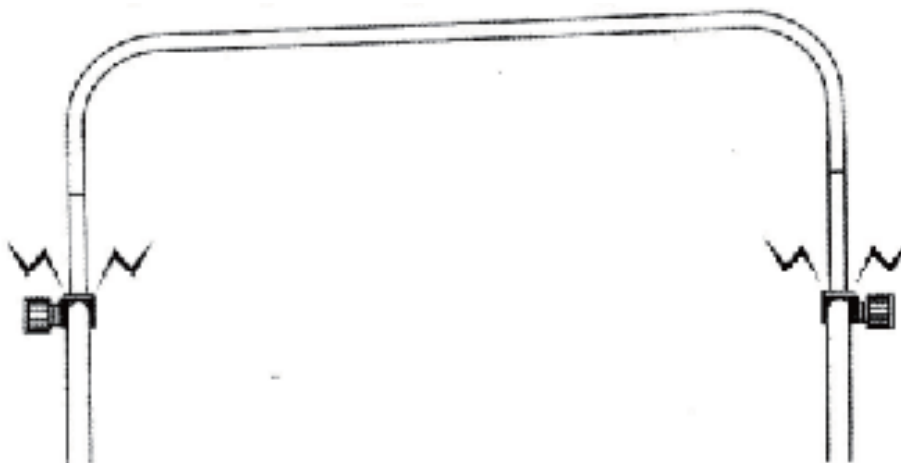

After the adjustment on both sides is at the same height level (there is a scale line on the adjustment rod, and the scale line shall prevail), after the adjustment rods on both sides are raised to the same height at the same time, tighten the knob.

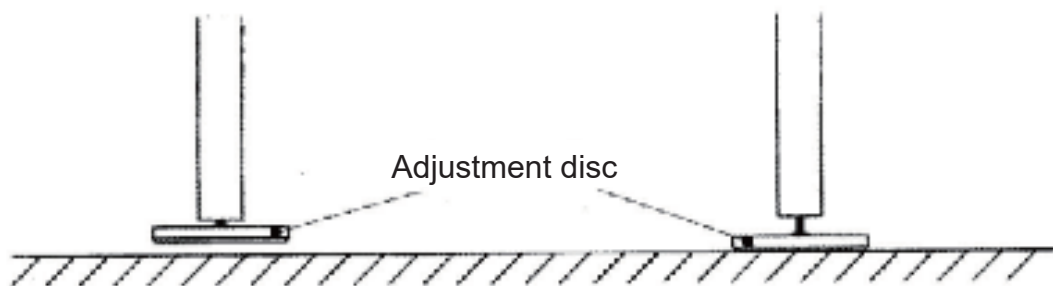

Base disc: when there is a gap with the ground, just rotate and adjust to contact with the ground.



● **Way of folding**

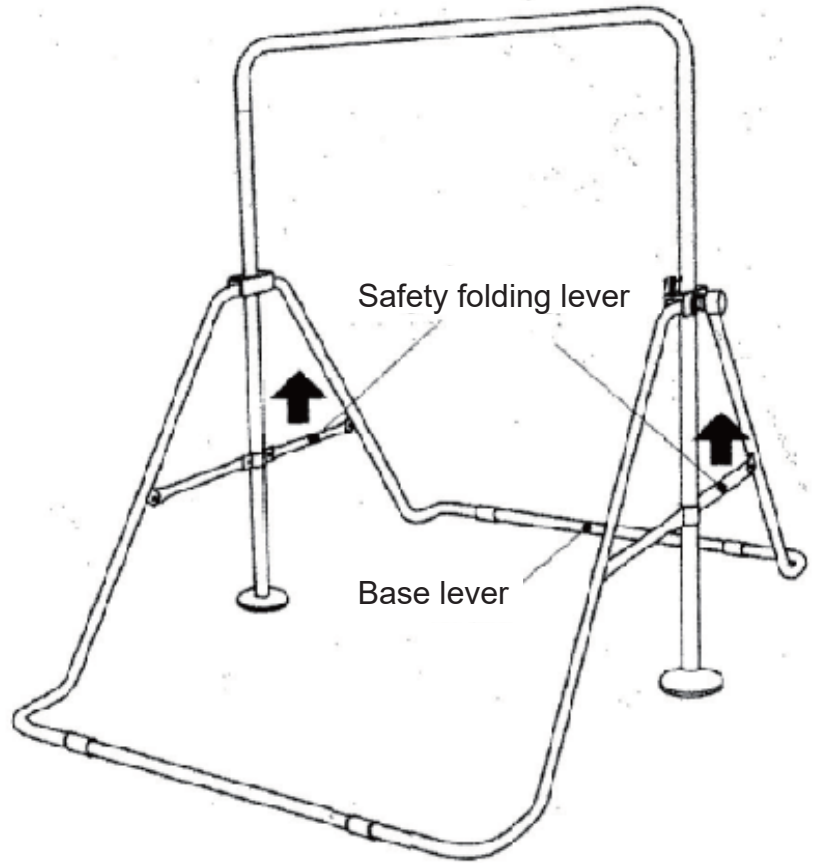

Hold the safety folding lever with both hands at the same time, and pull upwards, the equipment can be folded and closed, as shown in the figure

