



### **CAUTION:**

- This package contains small parts which are for adult assembly only.
- Care should be taken when unpacking and assembling toy.



### **WARNING**

**Adult Assembly Required**

**IMPORTANT, RETAIN FOR FUTURE REFERENCE: READ CAREFULLY**

# **ASSEMBLY INSTRUCTION**

## **Warning:**







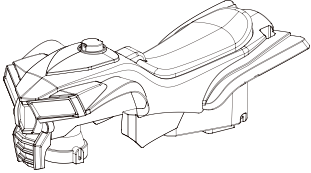

1. The Ride-On car is designed for children aged 18 + months. The rider's weight must not exceed 27kgs (60lbs).
2. The product is designed to only seat 1 child at a time to avoid injuries.
3. Parental guidance and supervision are strongly advised.
4. To ensure safety, all parts of the product must be assembled by an adult.
5. Avoid going near streets, crossroads, traffic areas, swimming pools and stairs when riding the car.
6. Check the product regularly to make sure everything is secure.  
In particular, the nut and bolt on the steering wheel must be tightened.
7. Dangers may occur if the product is not correctly assembled.
8. Shoes must be worn.

## **Battery Handling:**

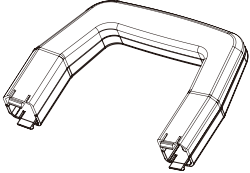
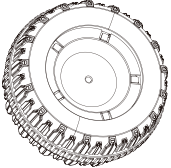
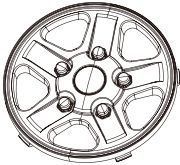
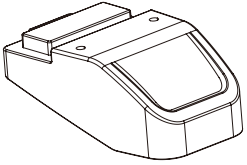
1. Battery must be handled by adults only.
2. Always remove exhausted batteries.
3. Use 2 x AA size batteries (not included) to make the lights and sound work.
4. Alkaline batteries are recommended.
5. Always remove batteries when the unit is not going to be used for an extended period of time.
6. When batteries need replacing, make sure to replace all of them at the same time.
7. Do not mix old and new batteries.
8. Do not mix different types of batteries (Alkaline Standard, Carbon-Zinc and Nickel-Cadmium).
9. Do not dispose of batteries in fire, they may explode or leak.

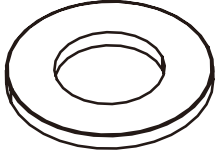
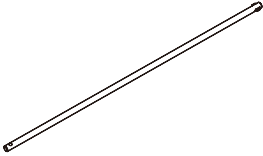
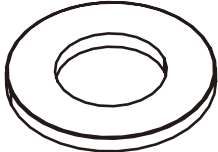
# ASSEMBLY INSTRUCTIONS

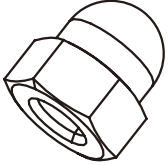
## COMPONENTS LIST

1. Car body×1		2. Handle×1	
3. Backrest ×1		4. Wheel×4	
5. Wheel cap×4		6. Anti-tumble shelf×1	
7. Plastic ring ×4		8. Cotter Pin×2	
9. Axle ×4		10. Washer ×4	
11. Bolt×1		12. Nut×1	
13. Screw ×2			

< Step 1 >

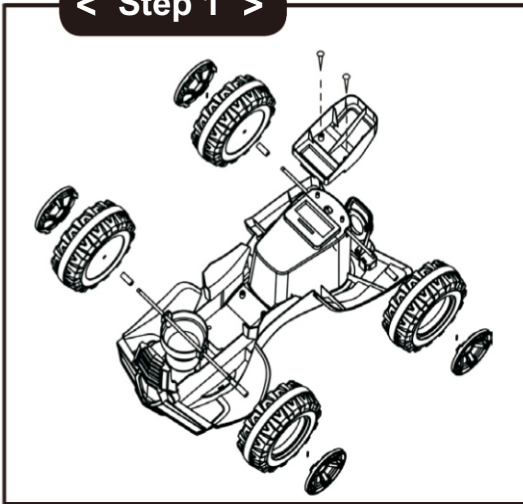

**How to assemble the wheels :**

- Insert the axle through plastic rings into the main body of the car, tightening using a cotter pin.
- Assemble the four wheel caps.

**How to assemble the anti-tumble shelf:**

- Place the anti-tumble shelf into the rear of the body.
- Assemble the two screws with a screwdriver.

< Step 2 >



**How to assemble the handle:**

- Place the handle.
- Insert the bolt into the hole and tighten with a screwdriver.

**How to assemble the toddler bar:**

- Place the toddler bar over the holes in the rear of the product.
- While holding the front of the vehicle down, push firmly on the toddler bar so that it fits into the holes. Ensure the toddler bar is properly fitted.

**BATTERY CHANGE**

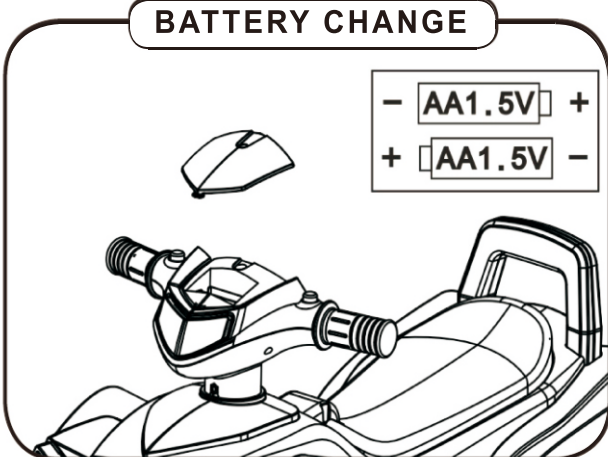

**How to change the battery:**

- Loosen the screw with a screwdriver.
- Keep the screw in a safe place away from children's reach.
- Put 2AA batteries in the battery house.
- Press the buttons on the handle to check the batteries are functioning and to make sure the revving engine, the horn and the blinking lights are properly activated, before securing the screws.”

