



INfga032_US

370-134









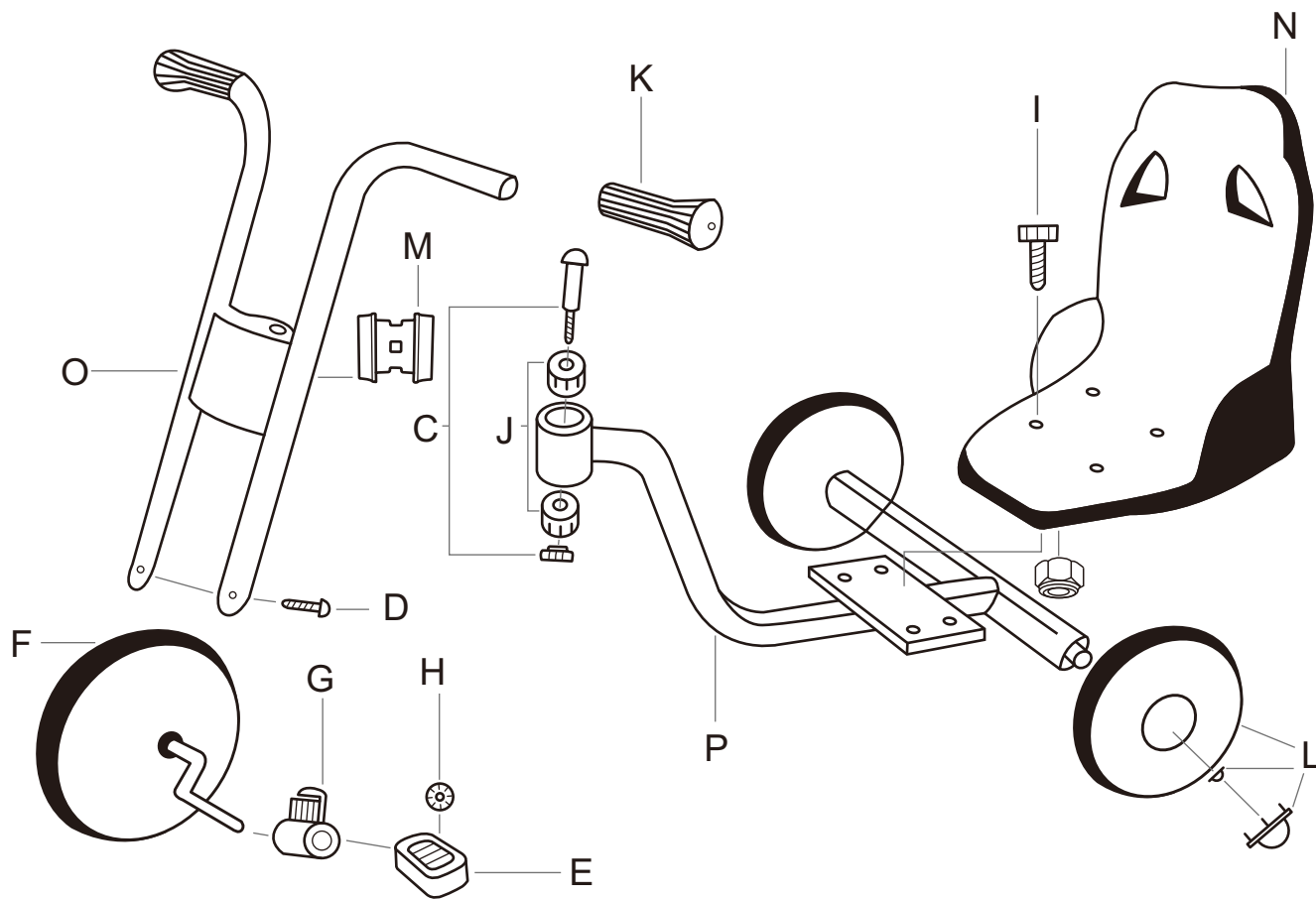





2+ Age



READ AND SAVE THIS INSTRUCTION FOR FUTURE USE

ASSEMBLY INSTRUCTION

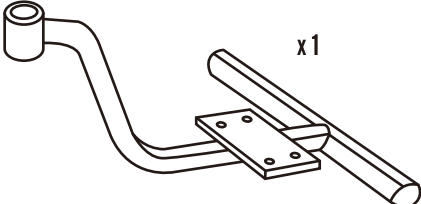

A	 x1	G	 x2	M	 x1
B	 x1	H	 x2		
C	 = x1 set	I	 = x1 set x4		
D	 x2	J	 x2		
E	 x2	K	 x2	N	
F	 x1	L	 = x1 set x2		
O	 x1	P	 x1		

Instruction for Use and Warnings

Suitable for child/children of 2-6 years old.

Max weight: 40 kgs .

Keep this address for future reference.

WARNING

Use appropriate protective equipment.

Do not ride in traffic lanes.

Adult supervision required.

Never use near steps, sloped driveways, hills, roadways, alleynes, swimming pool areas.

Always wear shoes.

Never allow more than 1 user.

Maintenance instructions

Check condition of steering assembly, handlebar grips, wheels and metals parts from time to time.

If nylon bearings in head tube or rear wheels make noise lubricate with acid free grease or oil.

Use original spare parts only.

US



001-877-644-9366
customerservice@aosom.com

CA



001-855-537-6088
customerservice@aosom.ca

UK



0044-800-240-4004
enquiries@mhstar.co.uk

DE



0049-(0)40-88307530
service@aosom.de

FR



0033-1-84166106
contact@aosom.fr

ES



0034-931294512
atencioncliente@aosom.es

IT



0039-0249471447
clienti@aosom.it