



INfgc013_US_CA







370-133

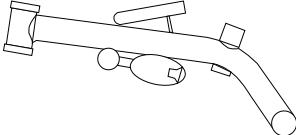
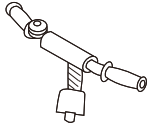
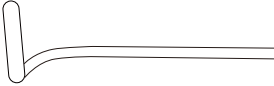

Baby Tricycle

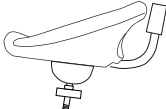
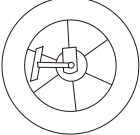
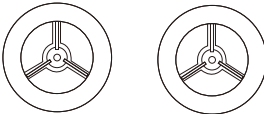
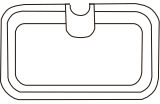
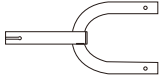
READ AND SAVE THIS INSTRUCTION FOR FUTURE USE

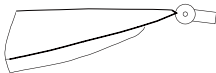
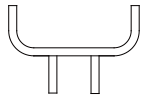
ASSEMBLY INSTRUCTION

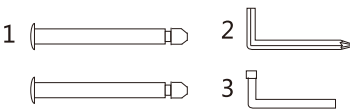
Item No	Name	Picture	
1	Frame		1
2	Handlebar		1
3	Up pushrod		1
4	Down pushrod		1
5	Seat		1
6	Front wheel		1
7	Rear wheel		2
8	rear basket	¹ 	1
9	Front fork		1
10	Armrest		1 Pair
11	Canopy		1
12	Canopy support		1
13	mud guard		1
14	Steering link		1
15	Rear axle and tools		1

2. Wheel and brake installation

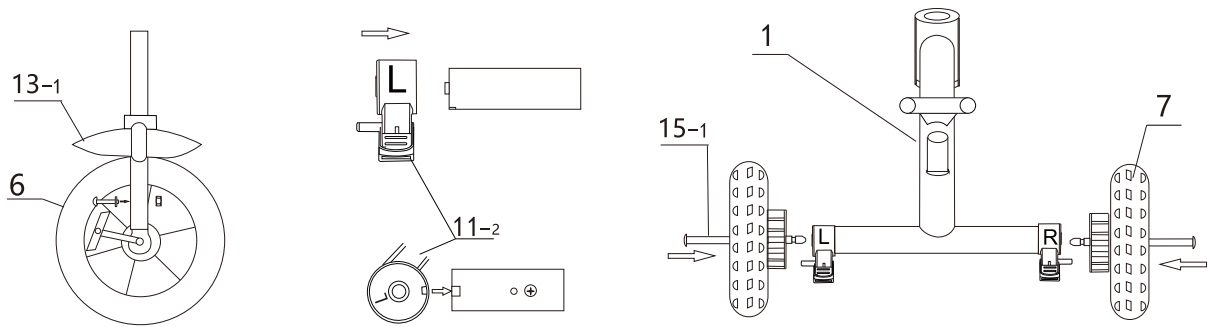

3. Tricycle installation

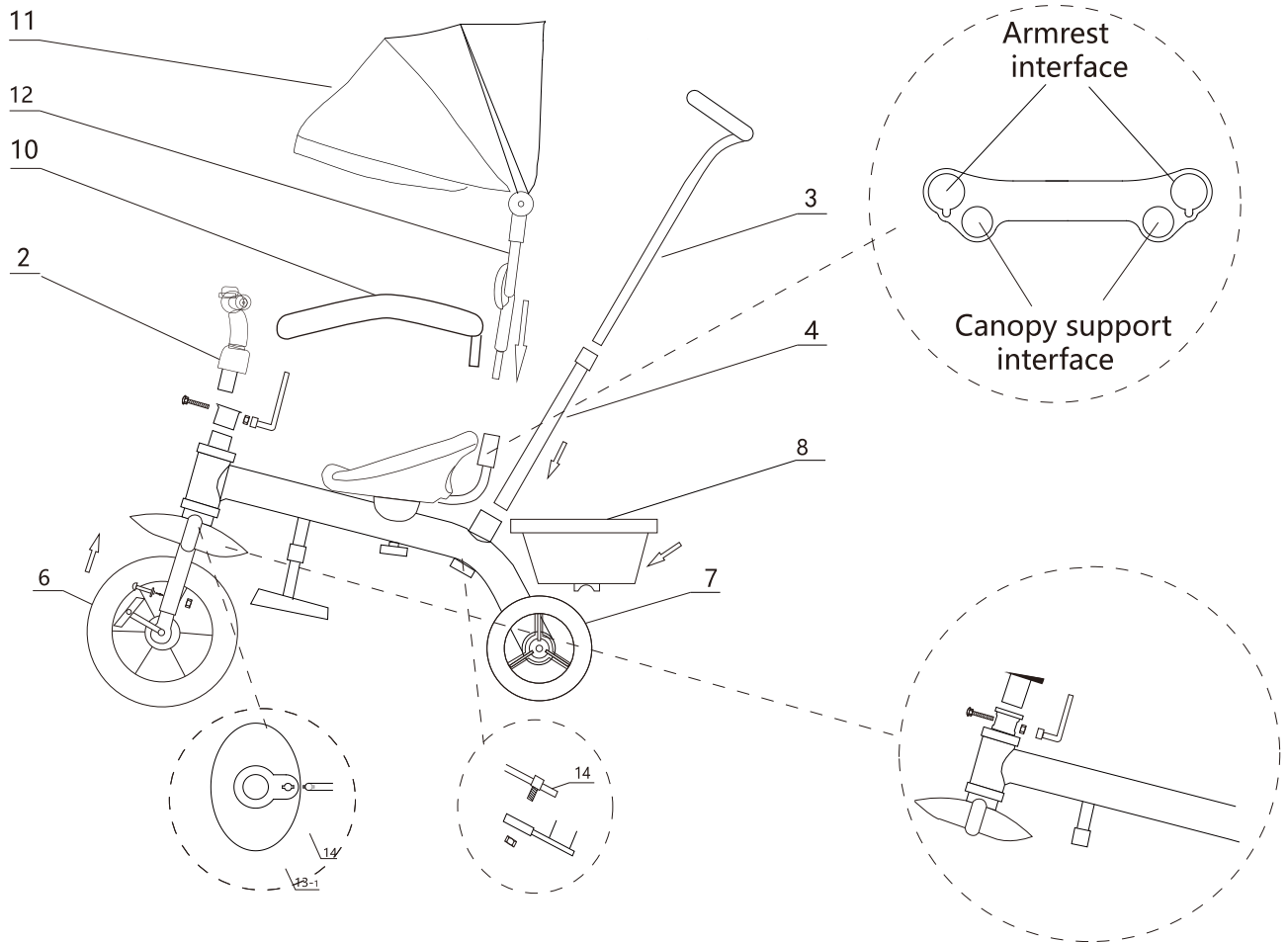

Notice

Please let your baby be familiar to the following safety rules, and observe the playing ground and your baby's ability before riding.

1. Carrying capacity:30KG, Adapted age:6-60months. Do not over loading for safety.
2. Must keep the kids in view and teach them how to use before riding.
3. Keep away from the street and road.
4. Keep away from the river, swimming pool or obstacles.
5. Do not ride in the dark or bad weather to avoid accident.
6. Only for one child to ride.
7. Do not put any parts of body include hands, head and foot under the wheel.

Warning:

1. Assembly by an adult.
2. Do not put the small parts into the mouth.
3. No overloading, carry capacity:30 KG.
4. Do not put away the Plastic bags to avoid suffocation when playing.
5. Do play this tricycle in right way.

Maintenance

1. Cleanliness: clean the tricycle by floppy cloth instead of auto wax or water avoiding degenerating.
2. Storage: keep away from fire, damp and other high temperature area.
3. Please inspect screw periodically to ensure it is not loose.

US



001-877-644-9366
customerservice@aosom.com

CA



001-855-537-6088
customerservice@aosom.ca

UK



0044-800-240-4004
enquiries@mhstar.co.uk

DE



0049-(0)40-88307530
service@aosom.de

FR



0033-1-84166106
contact@aosom.fr

ES



0034-931294512
atencioncliente@aosom.es

IT



0039-0249471447
clienti@aosom.it